

F

MODULES

YUKEN's Modular Valves are stack type valves, and require no piping. They not only rationalise system build, but they also meet the technical requirements for a variety of hydraulic systems. Stacking systems is a new era in hydraulics.

The valves have standardized mounting surface conforming to ISO 4401 and optimum thickness for each size. Any hydraulic circuits can be easily composed by stacking the valves with mounting bolts. The valves can be used widely for hydraulic systems for various industries such as machine tools, special purpose machines, ships and steel mill equipment.

Valve Type	Max. Operating Pressure MPa (PSI)	Maximum Flow		Page
		L/min	U.S.GPM	
005 Series Modular Valves	25 (3630)	005		517
01 Series Modular Valves	31.5 (4570)	01	01 *	535
03 Series Modular Valves	25 (3630)	03	03 *	577
06 Series Modular Valves	25 (3630)	06		619
10 Series Modular Valves	25 (3630)	10		633

★ Maximum Flow for Throttle and Check Modular Valves.

Hydraulic Fluids

Fluid Types

Any type of hydraulic fluid listed in the table below can be used.

Petroleum Base Oils	Use fluids equivalent to ISO VG 32 or VG 46.
Synthetic Fluids	Use phosphate ester or polyol ester fluids. When phosphate ester fluid is used, prefix "F-" to the model number because the special seals (fluororubber) are required to be used.
Water-containing Fluids	Use water-glycol fluid.

Note: For use with hydraulic fluids other than those listed above, please consult your Yuken representatives in advance.

Recommended Fluid Viscosity and Temperature

Use hydraulic fluids which satisfy the both recommended viscosity and oil temperatures given in the table below.

Name	Viscosity	Temperature
005 Series Modular Valves	15 - 200 mm ² /s (77 - 900 SSU)	-15 - +60°C (5 - 140°F)
01 Series Modular Valves 03 Series Modular Valves 06 Series Modular Valves 10 Series Modular Valves	15 - 400 mm ² /s (77 - 1800 SSU)	-15 - +70°C (5 - 160°F)

Control of Contamination

Due caution must be paid to maintaining control over contamination of the hydraulic fluids which may otherwise lead to breakdowns and shorten the life of the valve.

Name	Contamination	Nominal Filtration
005 Series Modular Valves	Within NAS1638 - Grade 11	20 μm or less
01 Series Modular Valves 03 Series Modular Valves 06 Series Modular Valves 10 Series Modular Valves	Within NAS1638 - Grade 12	20 μm or less

High Pressure, High Flow Rate Modular Valves

Features

1. Installation and mounting space can be minimized.
2. No special skill is required for assembly and any addition or alteration of the hydraulic circuit can be made quickly and easily.
3. Problems such as oil-leaks, vibration and noise which may be caused by piping are minimized, increasing the reliability of the hydraulic system.
4. Maintenance and system check-ups can be easily carried out as they are normally installed in stackable units.

Specifications

Series	Valve Size	Max. Operating Pressure MPa (PSI)	Max. Flow L/min (U.S.GPM)	Number of Stack ^{★2}
005 Series	—	25 (3630)	15 (3.96)	1 to 4 stacks
01 Series	1/8	31.5 (4570)	35 [60] ^{★1} (9.24 [15.9]) ^{★1}	1 to 5 stacks ^{★3}
03 Series	3/8	25 [31.5] ^{★4} (3630 [4570]) ^{★4}	70 [120] ^{★1} (18.5 [31.7]) ^{★1}	1 to 5 stacks
06 Series	3/4	25 (3630)	500 (132)	
10 Series	1-1/4	25 (3630)	800 (211)	

- ★1. The values in parentheses represent the max. flow rates for throttle modular valves (MSP) and throttle check modular valves (MSA/MSB/MSW).
- ★2. Solenoid operated directional valve is included in the number of stack.
- ★3. Solenoid operated directional valve is included in the number of stack. If the working pressure is above 25 MPa (3630 PSI), the maximum number of layers in a stack is 4 including the solenoid operated directional valve.
- ★4. The value range in parentheses represents the tightening torque requirements if the operating pressure is above 25 MPa (3630 PSI).

Mounting Surface

Mounting surface dimensions conform to ISO 4401 (Hydraulic fluid power four port directional control valves mounting surface) as listed in the table below.

Name of Valve	ISO Mtg. Surface Code No.
01 Series Modular Valve	ISO 4401-AB-03-4-A
03 Series Modular Valve	ISO 4401-AC-05-4-A
06 Series Modular Valve	ISO 4401-AE-08-4-A
10 Series Modular Valve	ISO 4401-AF-10-4-A

Stacking Example

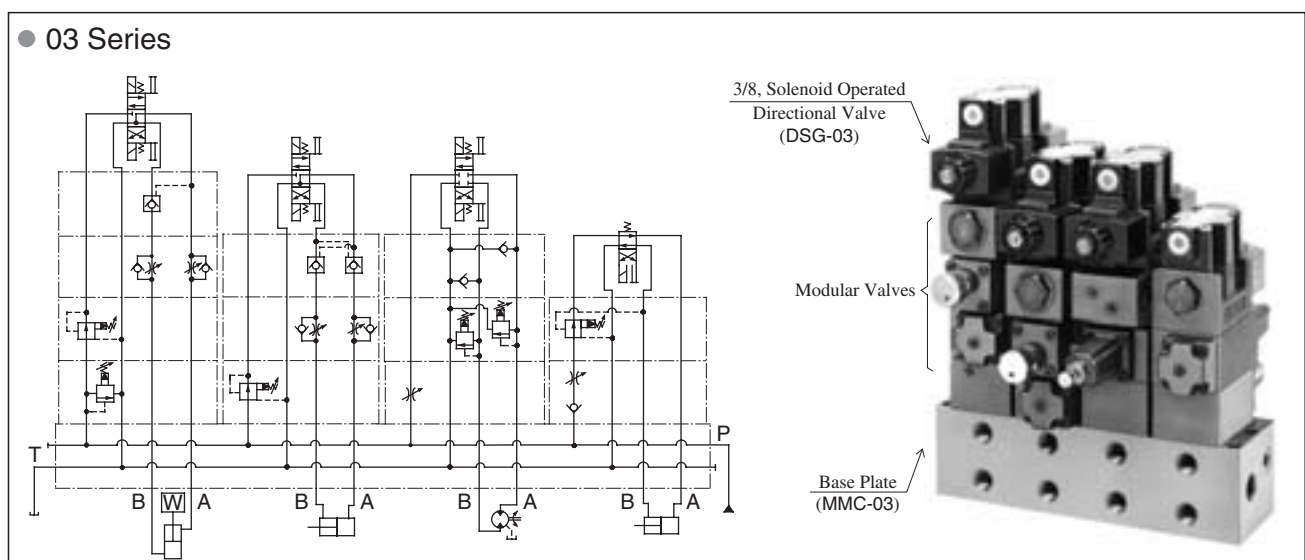

Instructions

Caution in the selection of valves and circuit designing

The selection of modular valves, to suit a particular function or hydraulic circuit, are made in exactly the same way as conventional valves, taking into account of the flow and pressure of each valve to be used. In some cases, the stacking system may be restricted, so please refer to the following instructions for stacking sequence. Please note, that when designing a system using modular stacking valves, due consideration should be given to working space for future maintenance.

Stacking sequence when using reducing valves (for "A" or "B" line) and pilot operated check valves.

Because reducing valves are spool type, there is an internal leakage. In the stacking sequence shown in the drawing left (incorrect), the cylinder moves due to leakage through the pilot pressure line.

Consequently, retaining the position of the cylinder using a pilot operated check valve becomes impossible. The stacking sequence shown in the drawing right (correct) is required in order to retain the cylinder position.

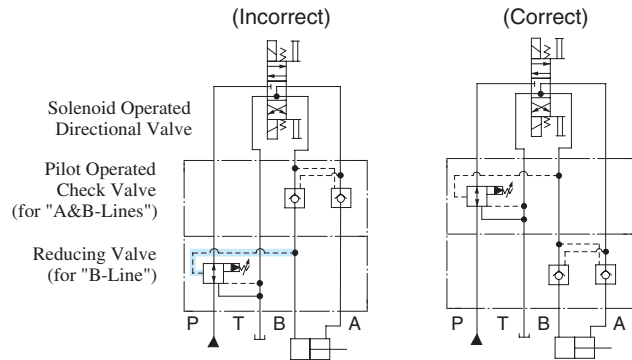

Stacking sequence when using reducing valves (for "A" or "B" line) and throttle and check valves (for metre-out).

In B to T flow in the drawing left (incorrect), pressure is generated at part with a throttle effect of the throttle and check valve. Depending upon the pressure so generated, the reducing valve may perform a pressure reducing function which causes a shortage of output power of the cylinder and spoils the smooth operation of the cylinder. Therefore, stacking sequence in the drawing right (correct) is required in this combination.

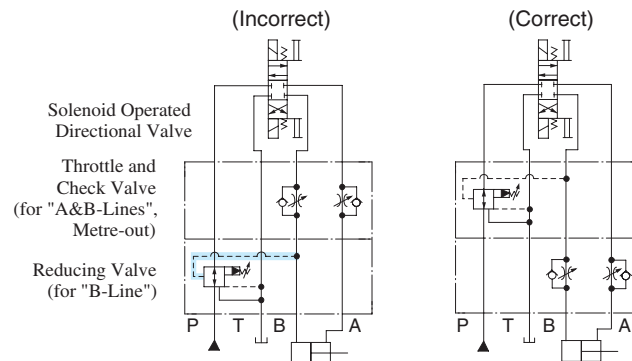

Stacking sequence when using pilot operated check valves and throttle and check valves (metre-out).

In A to T flow in the drawing left (incorrect), pressure is generated at part with a throttle effect of the throttle and check valve.

The pressure so generated acts to shut the pilot operated check valve and eventually creates an open and shut operation of the valve repeatedly which may cause the cylinder to have a knocking effect (the same effect will occur in the case of B to T flow). Therefore, the stacking sequence in the drawing right (correct) is required in this combination.

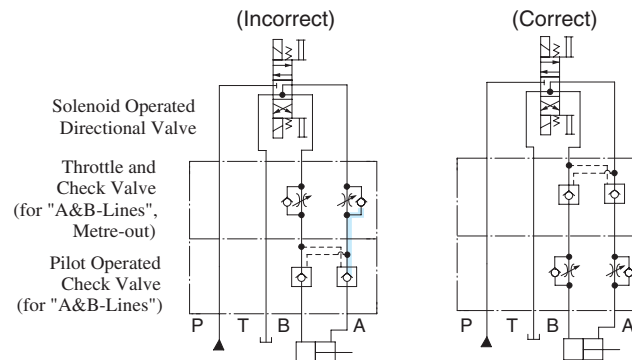

Stacking sequence when using brake valves and throttle and check valves.

In the drawing left (incorrect), pressure is generated at part (a load pressure and a back pressure from throttle effect). For structural reasons of the brake valve, the load pressure and back pressure act to open the valve, therefore, the setting pressure should be more than the pressure equal to the load pressure plus back pressure ($P_a + P_b$). If the setting pressure is less than $P_a + P_b$, the brake valve acts and brakes the movement of the actuator in operation, this eventually reduces the speed of the actuator.

On the contrary, if the setting pressure is more than $P_a + P_b$, shock may occur when braking the actuator since the setting pressure is too high against the load pressure. Therefore, the stacking sequence in the drawing right (correct) is required in this combination.

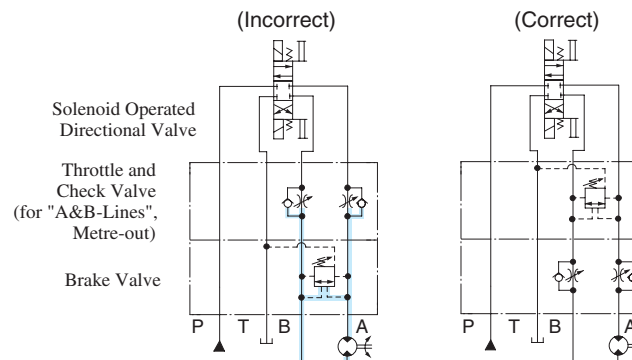

■ Base Plates and Sub-Plates

When mounting the modular valves, use base plates and sub-plates specified below. If these base plates and the sub-plates are not used, ensure that the mounting surface has a good machined finish.

Series	Base Plates		Sub-Plates	
	Model Numbers	Page	Model Numbers	Page
005 Series	MMC-005-* -20	531	DSGM-005* -20	342
01 Series	MMC-01-* -40	573	DSGM-01* -31	356
03 Series	MMC-03-T-* -21	615	DSGM-03* -40	373
06 Series	Consult your Yuken representative in advance.	—	DHGM-06* -50	402
10 Series	Consult your Yuken representative in advance.	—	DHGM-10* -40	403

■ Assembly

Assembly should be carried out in clean conditions and in accordance with the following procedure. Cautious attention should be paid to ensure that the interface of the valves are clean and free from dirt or other foreign materials.

● Assembly Procedure:

- 005 Series
 - 1) To stack modular valves and solenoid operated directional valves according to circuit requirements, match the O-ring surfaces to the mounting surface and check the alignment of the locating pins.
 - 2) Align the right and left sides of the stacked valves.
 - 3) Tighten the four mounting bolts to the specified tightening torque.
 - 4) Perform an operational test and re-check mounting bolt torque, re-tightening if required.
- 01-10 Series
 - 1) Screw-in the four stud bolts(06 and 10 series: six stud bolts), fully into the tapped holes on the mounting surface of the specified base plate, sub-plate or manifold.
 - 2) Stack the modular valves and solenoid operated directional valves in accordance with the hydraulic circuit, place the O-ring inserted surface face onto the base plate and make sure that the port arrangement of the modular valves are in the correct position before stacking the valves onto the stud bolts.
 - 3) Align both the end of the valves stacked.
 - 4) Screw-in the four nuts(06 and 10 series: six nuts) onto the stud bolts and tighten with the specified torque. After the test run, be sure to re-tighten the nuts firmly within the specified torque.

■ Pressure Drop

Pressure drop curves of the modular valves are those based on viscosity of 35 mm²/s (164 SSU) and specific gravity of 0.850.

When using the modular valves in conditions other than the above mentioned, find the appropriate values referring to the following table and formula.

- For any other viscosity, multiply the factors in the table below.

Viscosity	mm ² /s	15	20	30	40	50	60	70	80	90	100
		SSU	77	98	141	186	232	278	324	371	417
Factor		0.81	0.87	0.96	1.03	1.09	1.14	1.19	1.23	1.27	1.30

- For any other specific gravity (G'), the pressure drop (ΔP') may be obtained from the following formula.

$$\Delta P' = \Delta P (G'/0.850)$$

■ Mounting Bolts

Modular valves are mounted using stud bolts which are supplied in a kit form. When mounting, see the following table for tightening torque. After the test run, be sure to tighten again firmly within the specified torque.

Series	Bolt Kit Model Numbers	Tightening Torque Nm (in. lbs.)
005 Series	MBK-005-* -20	2.5-3.5 (22-31)
01 Series	MBK-01-* -30	5-6[6-7] (44-53[53-62])★
03 Series	MBK-03-* -10	12-15 (106-133)
06 Series	MBK-06-* -30	50-60 (443-531)
10 Series	MBK-10-* -10	150-170 (1330-1505)

★ The value range in parentheses represents the tightening torque requirements if the operating pressure is above 25 MPa (3630 PSI).

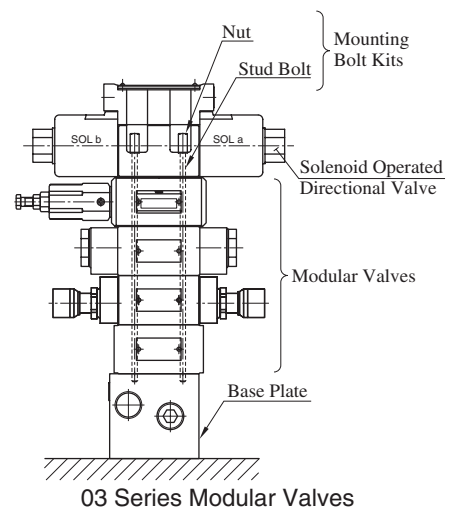
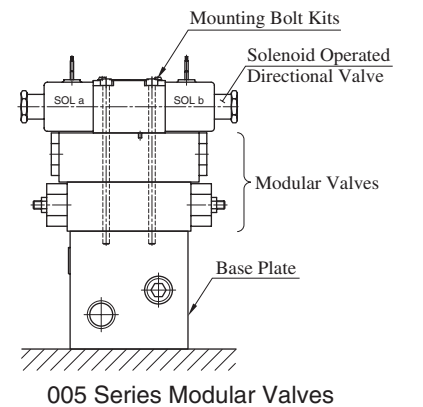

■ Interchangeability in Installation between Current and New Design

The model changed for the following models have been made.

Models	Model Numbers		Mtg. Interchangeability	Main changes
	Current	New		
005 Series	Throttle and Check Modular Valves	MSW-005-*-10	A MSB-005-*-20 W	Yes ● Modification for large flow use. ● Addition of the valve for A & B lines.
	Pilot Operated Check Modular Valves	MP ^B _W -005-2-10	A MPB-005-2-20 W	Yes ● Modification for large flow use. ● Addition of the valve for A lines.
	Base Plates	MMC-005-*-10	MMC-005-*-20	Yes Change of the port hole dia. for large flow use (3.4 Dia. → 4.3 Dia.).
	Bolt Kits	MBK-005-*-10	MBK-005-*-20	Yes ● Addition of bolt kit for 4-stage stacking. ● Change the bolt kit model numbers to conform to the required bolt length for the 01 to 10 series (See the table below for details.)
01 Series	Throttle Modular Valves	MSP-01-30	MSP-01-50	Yes Modification for large flow use.
	Throttle and Check Modular Valves	A MSB-01-**-*-40 W	A MSB-01-**-*-50 W	Yes Improved Controllability and Operability.
03 Series	Relief Modular Valves	MB*-03-*-20	MB*-03-*-30	Yes Higher Operating Pressure.
	Reducing Modular Valves	P MRA-03-*-20 B	P MRA-03-*-30 B	Yes Modification for large flow use.



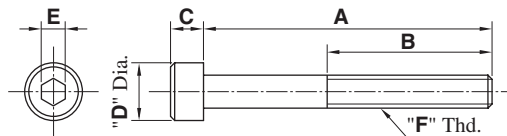







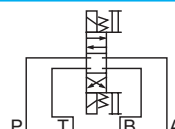





■ Comparison of MBK-005 bolt kit model numbers



Bolt Kit Model Numbers		Dimensions mm (Inches)					"F" Thd.	The number of the laminating steps quantity of valves to be stacked including solenoid operated directional Valve
(New) 20 Design	(Old) 10 Design	A	B	C	D	E		
MBK-005-01-20	MBK-005-02-10	65(2.56)	20 (0.79)	4 (0.16)	7 (0.28)	3 (0.12)	M4	2
MBK-005-02-20	MBK-005-03-10	95(3.74)						3
MBK-005-03-20	—————	125(4.92)						4
MBK-005-05-20	MBK-005-05-10	35(1.38)						1
MBK-005-01-2090	MBK-005-02-1090	65.1(2-9/16)	22.4 (0.88)	4.17 (0.164)	6.86 (0.27)	3.6 (9/64)	No.8-32 UNC	2
MBK-005-02-2090	MBK-005-03-1090	95.2(3-3/4)						3
MBK-005-03-2090	—————	125.4(4-15/16)						4
MBK-005-05-2090	MBK-005-05-1090	34.9(1-3/8)						1

005 Series Modular Valves

Type of Modular Valve

Class	Model Numbers	Graphic Symbols	Page
	Solenoid Operated Directional Valve DSG-005-***-*-40		336
Pressure Control Valves	Relief Valves (for "P-Line") MBP-005-*-20		518
	Reducing Valves (for "P-Line") MRP-005-*-20/2090		521
Flow Control Valves	Throttle and Check Valves (for "A-Line", Metre-out) MSA-005-X-20		524
	Throttle and Check Valves (for "A-Line", Metre-in) MSA-005-Y-20		
	Throttle and Check Valves (for "B-Line", Metre-out) MSB-005-X-20		
	Throttle and Check Valves (for "B-Line", Metre-in) MSB-005-Y-20		
	Throttle and Check Valves (for "A&B-Lines", Metre-out) MSW-005-X-20		
	Throttle and Check Valves (for "A&B-Lines", Metre-in) MSW-005-Y-20		
Directional Control Valves	Pilot Operated Check Valves (for "A-Line") MPA-005-2-20		527
	Pilot Operated Check Valves (for "B-Line") MPB-005-2-20		
	Pilot Operated Check Valves (for "A&B-Lines") MPW-005-2-20		
	Check Valves (for "P-Line") MCP-005-0-20		529
Modular Plates and Mounting Bolts	End Plates (Blocking plates) MDC-005-A-20		530
	Base Plates MMC-005-*-20/2080/2090		531
	Bolts Kits MBK-005-*-20/2090		534

Relief Modular Valves

Specifications

Model Numbers	Max. Operating Pressure MPa (PSI)	Max. Flow L/min (U.S.GPM)
MBP-005-*-20	25 (3630)	15 (3.96)

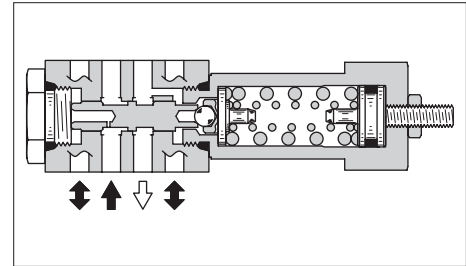
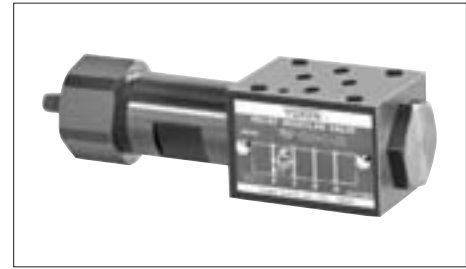

Model Number Designation

F-	MBP	-005	-C	-20	*
Special Seals	Series Number	Valve Size	Pres. Adj. Range MPa (PSI)	Design Number	Design Standard
F: Special Seals for Phosphate Ester Type Fluids (Omit if not required)	MBP : Relief Valve for P-Line	005	C: *-16 ^{★1} (*-2320) H: 7-25 (1020-3630)	20	Refer to ^{★2}

★1. See the "Minimum Adjustment Pressure" of the next page for the item marked *.

★2. Design Standards: None..... Japanese Standard "JIS", European Design Standard and N. American Design Standard

Instructions

- The minimum adjustment pressure equals the value obtained from the minimum adjustment pressure characteristics plus the tank line back pressure of the next page. This back pressure should include the value of the T-line pressure drop characteristics of the valves stacked to the base plate side of the modular valve.
- To make pressure adjustment, loosen the lock nut and turn the pressure adjustment screw clockwise or anti-clockwise. For an increase of pressure, turn the screw clockwise. Be sure to re-tighten the lock nut firmly after making adjustment to the pressure.
- In case of a small flow, the setting pressure may become unstable. To avoid this, refer to the minimum flow characteristic curve of the [next page](#) and use the valve within a range as shown with .

Graphic Symbol

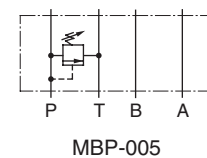

Typical Performance Characteristics

Hydraulic Fluid: Viscosity 35 mm²/s (164 SSU), Specific Gravity 0.850

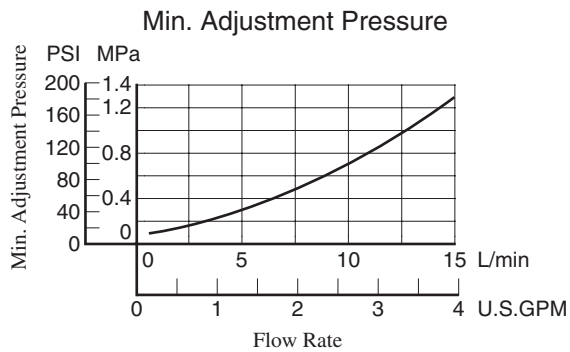
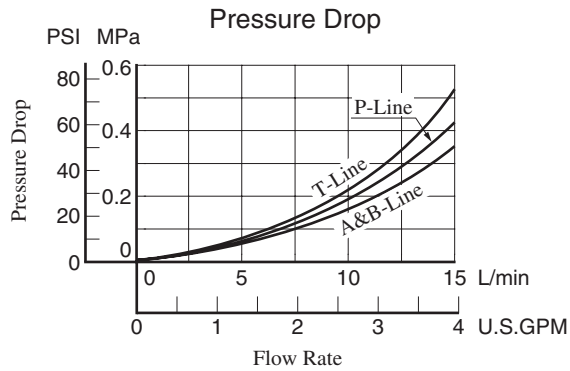
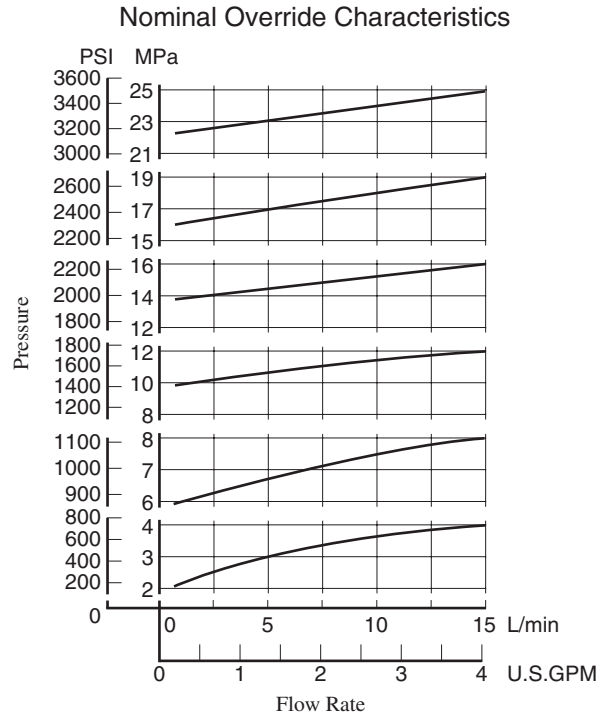
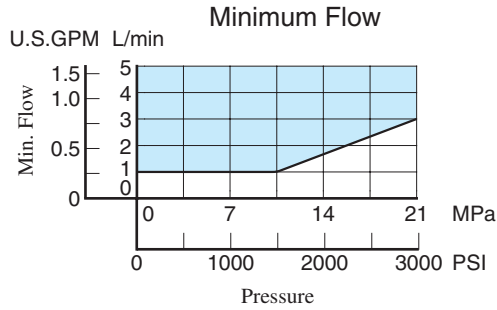

MBP-005-*-20

DIMENSIONS IN MILLIMETRES (INCHES)

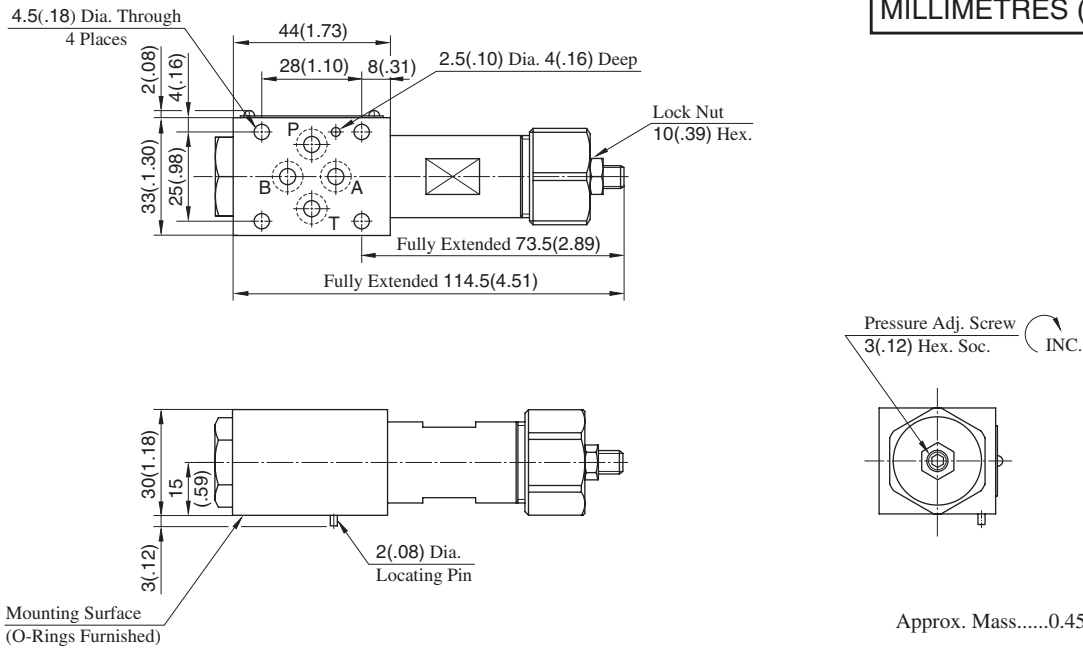

Approx. Mass.....0.45 kg(.99 lbs.)

Spare Parts List

MBP-005-*-20

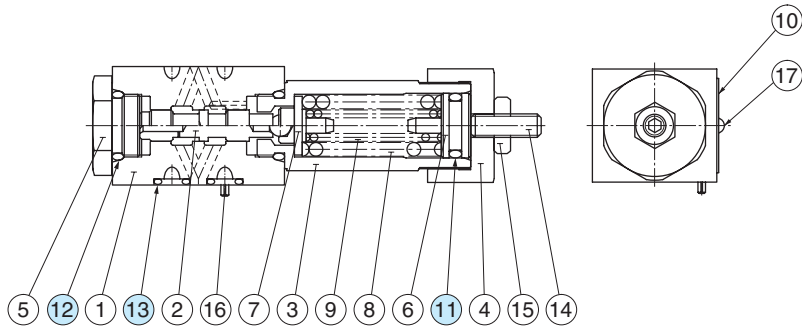

List of Seals

Item	Name of Parts	Part Numbers	Qty.	Remarks
11	O-Ring	SO-NA-P12.5	1	Included in Seal Kit Kit No. : KS-MBP-005-20
12	O-Ring	SO-NB-P14	2	
13	O-Ring	SO-NB-P6	4	

Reducing Modular Valves

Specifications

Model Numbers	Max. Operating Pressure MPa (PSI)	Max. Flow L/min (U.S.GPM)
MRP-005-*-20/2090	25 (3630)	15 (3.96) *

★ If the pressure is set below 1.6 MPa (232 PSI), the maximum flow is limited. See the minimum adjustment pressure vs. maximum flow characteristics and during use, stay within the shaded zone on the graph.

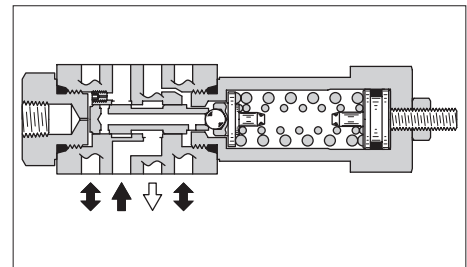

Model Number Designation

F-	MRP	-005	-B	-20	*
Special Seals	Series Number	Valve Size	Pres. Adj. Range MPa (PSI)	Design Number	Design Standard
F: Special Seals for Phosphate Ester Type Fluids (Omit if not required)	MRP: Reducing Valve for P-Line	005	B: *-7 (*-1020) ★ C: 3.5-16 (510-2320) H: 7-24.5 (1020-3550)	20	Refer to ★ 2

★ 1. See the "Minimum Adjustment Pressure vs. Maximum Flow" of the next page for the item marked *.

★ 2. Design Standards: None Japanese Standard "JIS" and European Design Standard 90 N. American Design Standard

Instructions

- The minimum adjustment pressure equals the value obtained from the minimum adjustment pressure characteristics plus the tank line back pressure of the [next page](#). This back pressure should include the value of the T-line pressure drop characteristics of the valves stacked to the base plate side of the modular valve.
- To make pressure adjustment, loosen the lock nut and turn the pressure adjustment screw clockwise or anti-clockwise. For an increase of pressure, turn the screw clockwise. Be sure to re-tighten the lock nut firmly after making adjustment to the pressure.

Graphic Symbol

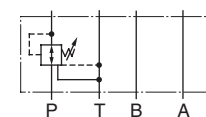

MRP-005

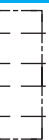

■ Typical Performance Characteristics

Hydraulic Fluid: Viscosity 35 mm²/s (164 SSU), Specific Gravity 0.850

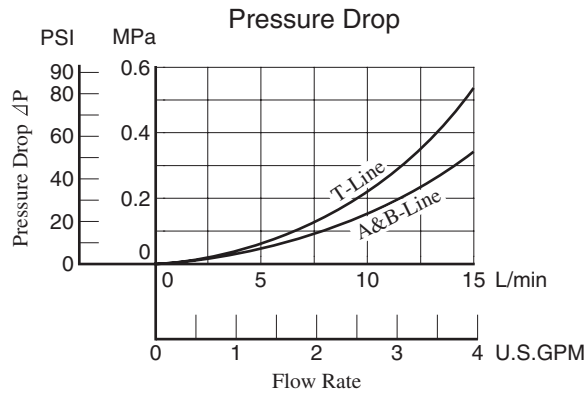

Pres. Drop at Spool Fully Open (P-Line)

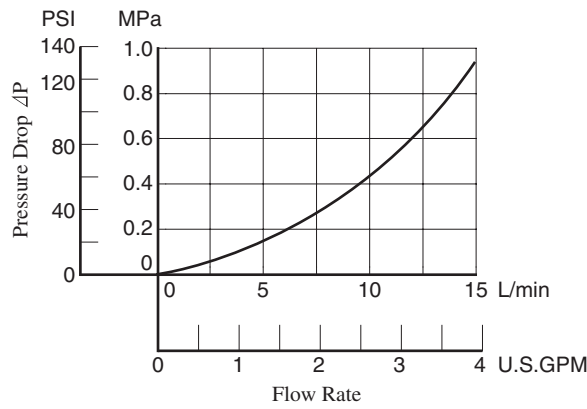

Min. Adjustment Pressure vs. Max. Flow

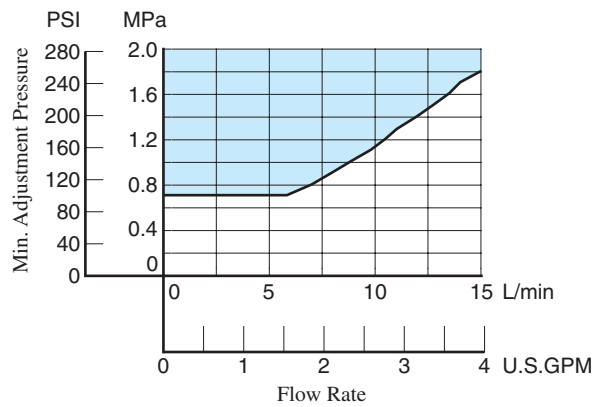

MRP-005-*-20/2090

DIMENSIONS IN MILLIMETRES (INCHES)

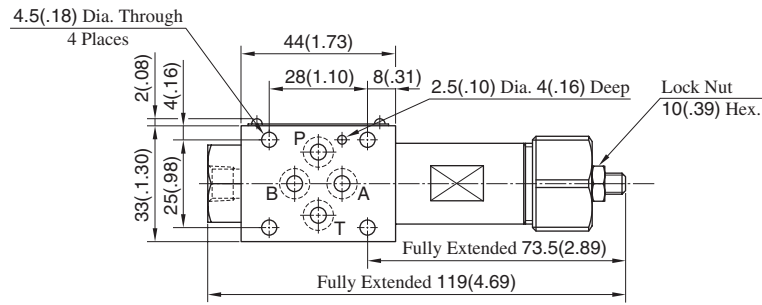

Model Numbers	Thread Size "C" Thd.
MR*-005-*-20	Rc 1/8 = 1/8 BSP.Tr
MR*-005-*-2090	1/8 NPT

Pressure Gauge Connection "C" Thd.

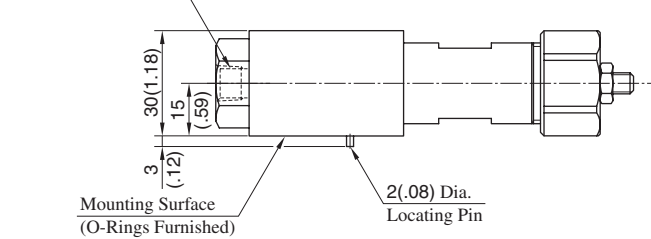

Pressure Adj. Screw 3(.12) Hex. Soc. INC.

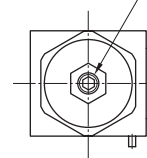

Approx. Mass.....0.45 kg(.99 lbs.)

Spare Parts List

MRP-005-*-20/2090

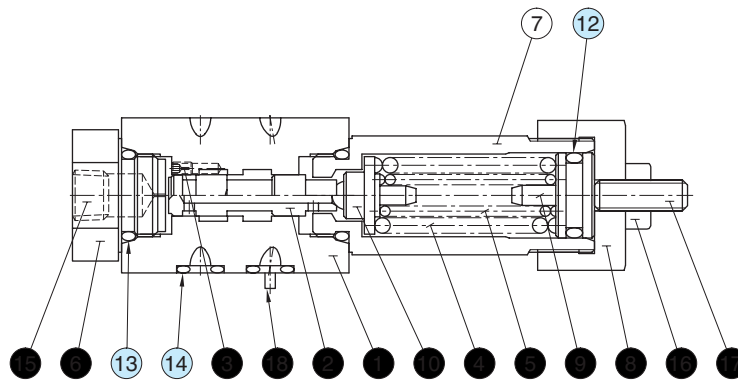

List of Seals

Item	Name of Parts	Part Numbers	Qty.	Remarks
12	O-Ring	SO-NA-P12.5	1	Included in Seal Kit Kit No. : KS-MRP-005-20
13	O-Ring	SO-NB-P14	2	
14	O-Ring	SO-NB-P6	4	

Throttle and Check Modular Valves

Specifications

Model Numbers	Max. Operating Pressure MPa (PSI)	Max. Flow L/min (U.S.GPM)
MSW-005-*-20 MSA-005-*-20 MSB-005-*-20	25 (3630)	15 (3.96)

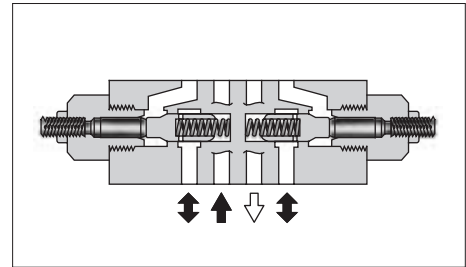
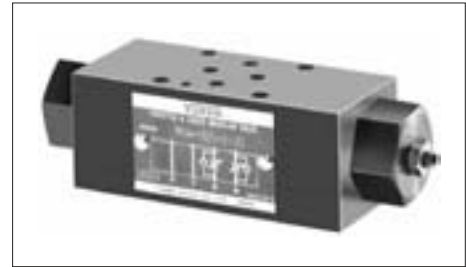

Model Number Designation

F-	MSW	-005	-X	-20	*
Special Seals	Series Number	Valve Size	Direction of Flow	Design Number	Design Standard
F: Special Seals for Phosphate Ester Type Fluids (Omit if not required)	MSA: Throttle and Check Valve for A-Line	005	X: Metre-out Y: Metre-in	20	Refer to ★
	MSB: Throttle and Check Valve for B-Line				
	MSW: Throttle and Check Valve for A&B-Lines				

★ Design Standards: None Japanese Standard "JIS", European Design Standard and N. American Design Standard

Flow Adjustment

To make flow rate adjustment, loosen the lock nut and turn the flow adjustment screw clockwise or anti-clockwise. To throttle the flow, turn the screw clockwise. Be sure to re-tighten the lock nut firmly after the adjustment of the flow rate is completed.

Graphic Symbols

Metre-out	Metre-in
<p>MSA-005-X</p>	<p>MSA-005-Y</p>
<p>MSB-005-X</p>	<p>MSB-005-Y</p>
<p>MSW-005-X</p>	<p>MSW-005-Y</p>

Typical Performance Characteristics

Hydraulic Fluid: Viscosity 35 mm²/s (164 SSU), Specific Gravity 0.850

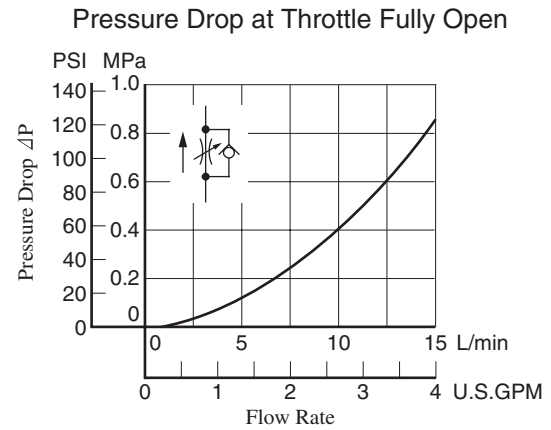
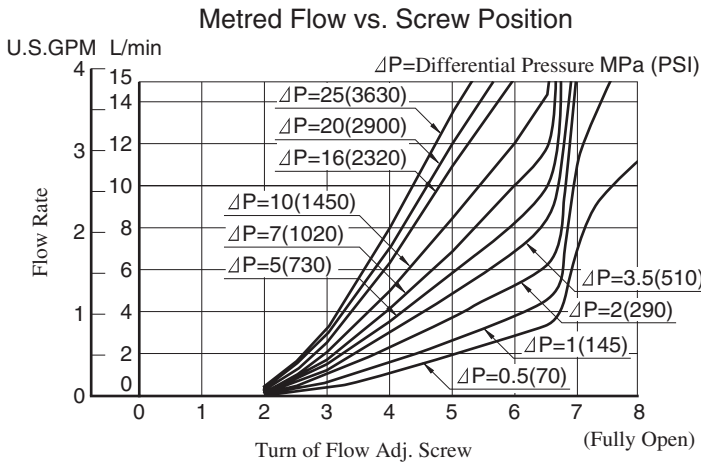
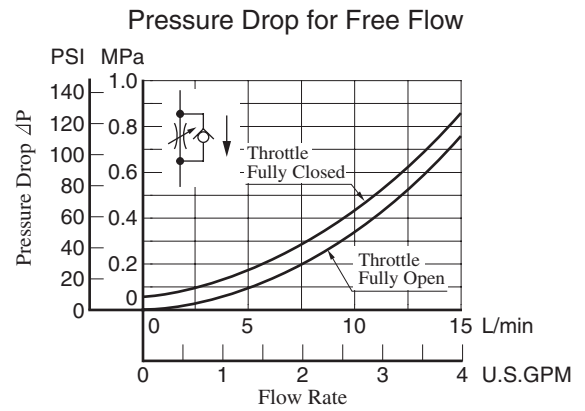
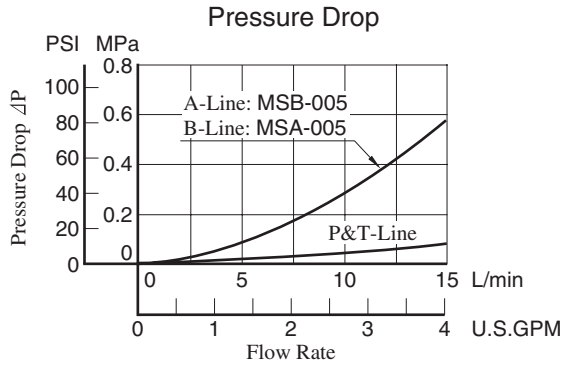

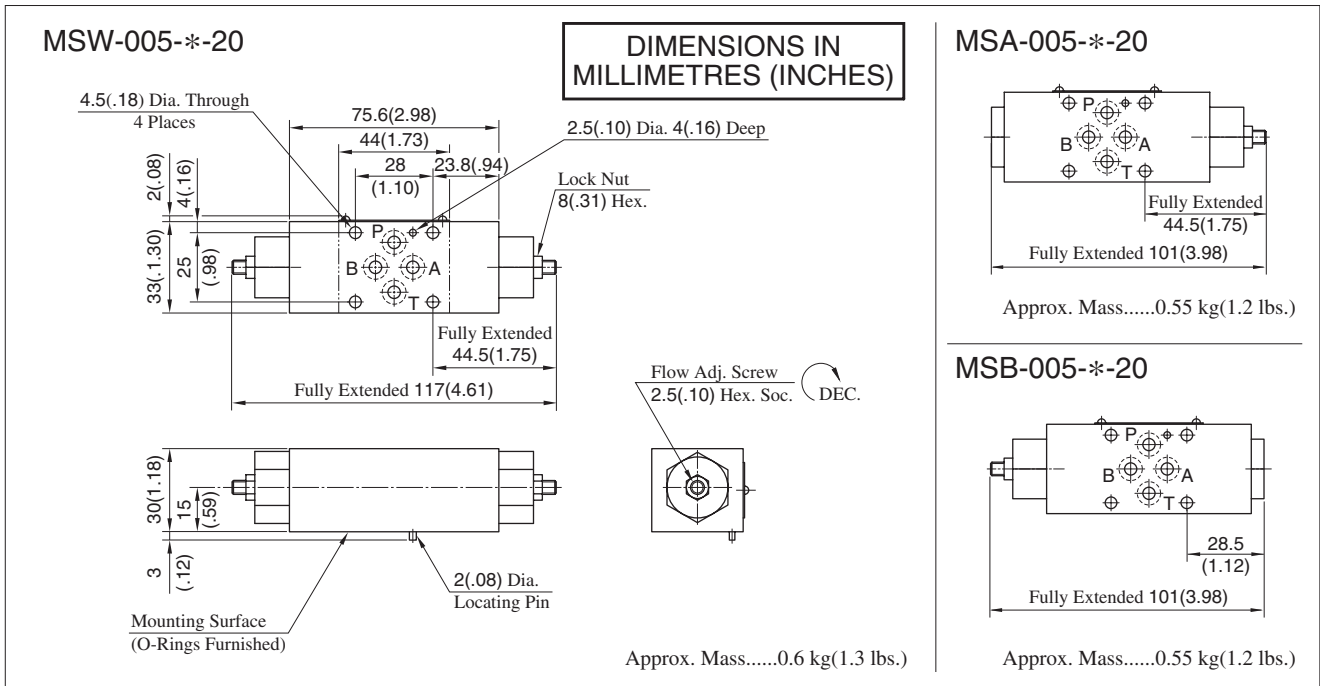

■ Spare Parts List

MSA-005-X_Y-20

MSB-005-X_Y-20

MSW-005-X_Y-20

● List of Seals

Item	Name of Parts	Part Numbers	Qty.	
			MSA MSB	MSW
7	O-Ring	SO-NA-P3	1	2
8	O-Ring	SO-NB-P6	4	4
9	O-Ring	SO-NB-P14	2	2
10	Back Up Ring	SO-BB-P3	1	2

● List of Seal Kits

Valve Model Numbers	Seal Kit Numbers
MSA-005	KS-MSA-005-20
MSB-005	
MSW-005	KS-MSW-005-20

Pilot Operated Check Modular Valves

Specifications

Model Numbers	Max. Operating Pressure MPa (PSI)	Max. Flow L/min (U.S.GPM)
MPA-005-2-20 MPB-005-2-20 MPW-005-2-20	25 (3630)	15 (3.96)

Model Number Designation

F-	MPW	-005	-2	-20	*
Special Seals	Series Number	Valve Size	Cracking Pressure MPa (PSI)	Design Number	Design Standard
F: Special Seals for Phosphate Ester Type Fluids (Omit if not required)	MPA: Pilot Operated Check Valve for A-Line MPB: Pilot Operated Check Valve for B-Line MPW: Pilot Operated Check Valve for A&B-Lines	005	2: 0.2 (29)	20	Refer to ★

★ Design Standards: None Japanese Standard "JIS", European Design Standard and N. American Design Standard

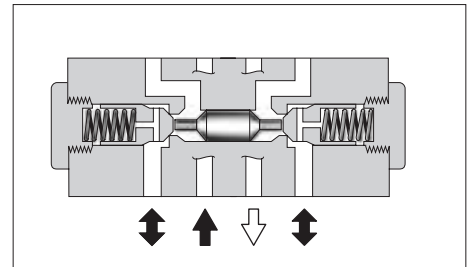

Graphic Symbols

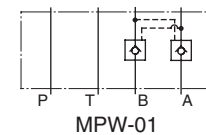
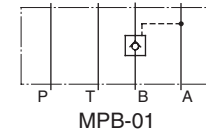
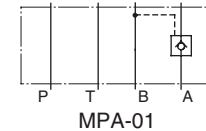

Typical Performance Characteristics

Hydraulic Fluid: Viscosity 35 mm²/s (164 SSU), Specific Gravity 0.850

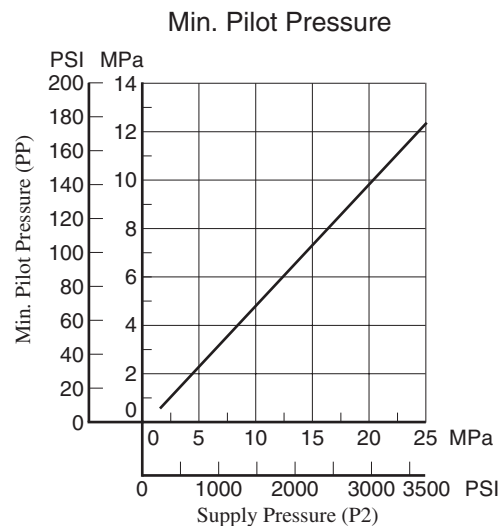
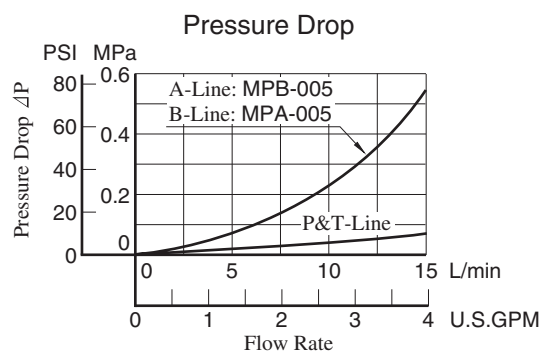
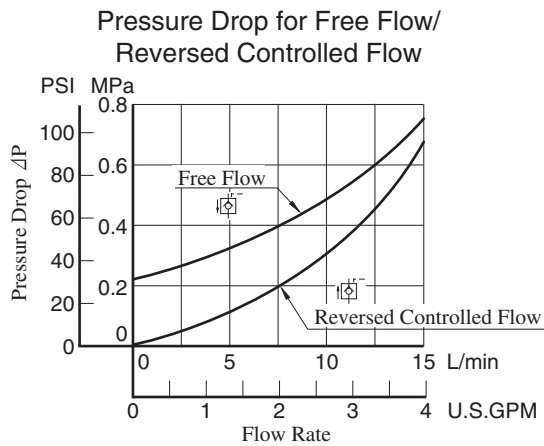

MPA-005-2-20
 MPB-005-2-20
 MPW-005-2-20

**DIMENSIONS IN
 MILLIMETRES (INCHES)**

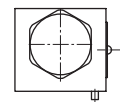
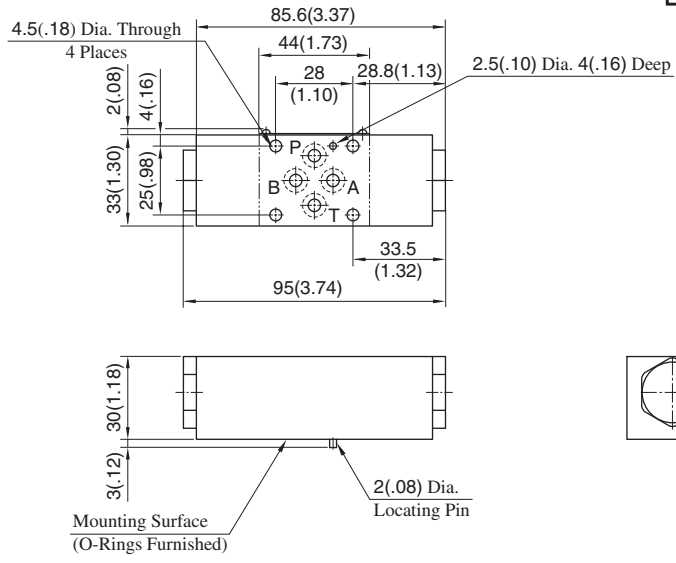

Approx. Mass.....0.55 kg(1.2 lbs.)

Spare Parts List

MPA-005-2-20

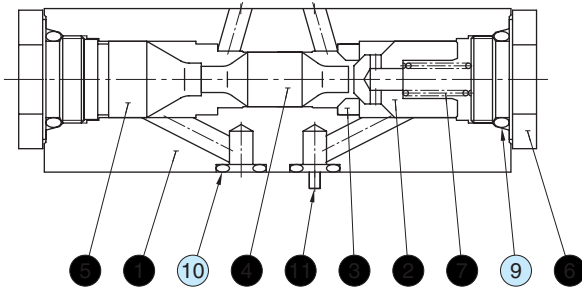

List of Seals

Item	Name of Parts	Part Numbers	Qty.	Remarks
9	O-Ring	SO-NB-P14	2	Included in Seal Kit
10	O-Ring	SO-NB-P6	4	Kit No. : KS-MPA-005-20

MPB-005-2-20

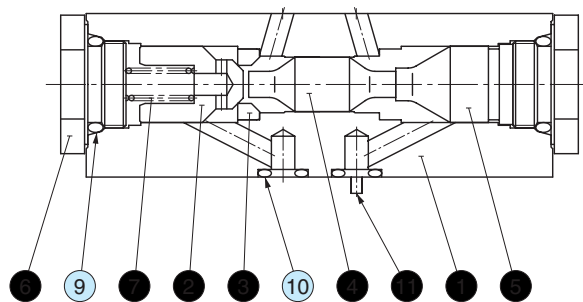

MPW-005-2-20

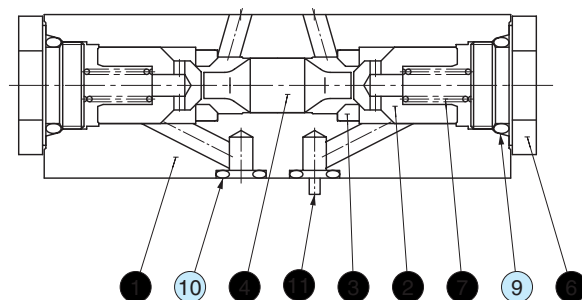

Check Modular Valves

Specifications

Model Number	Max. Operating Pressure MPa (PSI)	Max. Flow L/min (U.S.GPM)
MCP-005-0-20	25 (3630)	15 (3.96)

Model Number Designation

F-	MCP	-005	-0	-20	*
Special Seals	Series Number	Valve Size	Cracking Pressure MPa (PSI)	Design Number	Design Standard
F: Special Seals for Phosphate Ester Type Fluids (Omit if not required)	MCP: Check Valve for P-Line	005	0: 0.035(5)	20	Refer to ★

★ Design Standards: None Japanese Standard "JIS", European Design Standard and N. American Design Standard

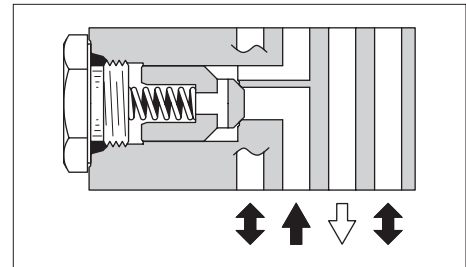

Graphic Symbol

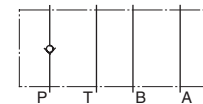

MCP-005

Typical Performance Characteristics

Hydraulic Fluid: Viscosity 35 mm²/s (164 SSU), Specific Gravity 0.850

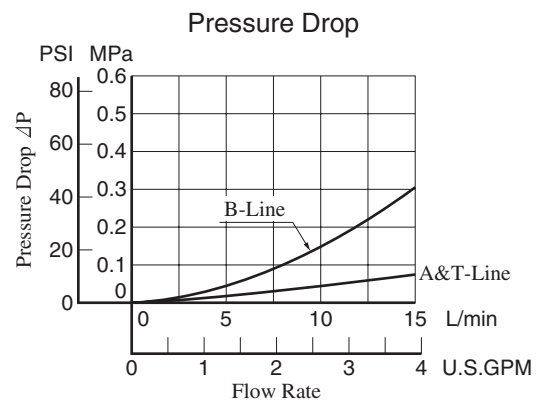
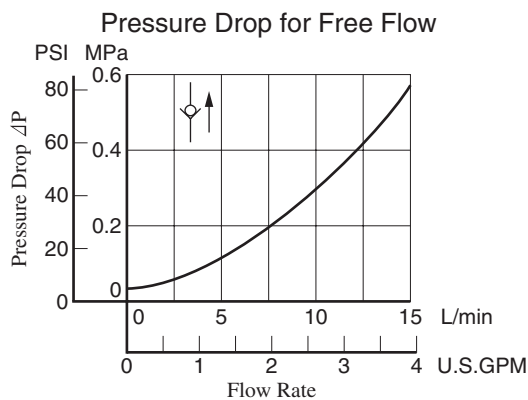

MCP-005-0-20

DIMENSIONS IN MILLIMETRES (INCHES)

Approx. Mass.....0.4 kg(.88 lbs.)

Spare Parts List

MCP-005-0-20

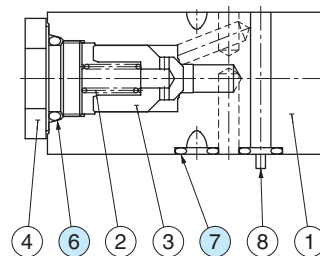

List of Seals

Item	Name of Parts	Part Numbers	Qty.	Remarks
6	O-Ring	SO-NB-P14	2	Included in Seal Kit
7	O-Ring	SO-NB-P6	4	Kit No. : KS-MPA-005-20

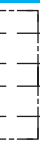

End Plates

Blocking plates are used for auxiliary mounting surface or for closing unnecessary circuits.

Specifications

Max. Operating Pressure ----- 25 MPa (3630 PSI)



Model Number Designation

F-	MDC	-005	-A	-20	*
Special Seals	Series Number	Plate Size	Type of Plate	Design Number	Design Standard
F: Special Seals for Phosphate Ester Type Fluids (Omit if not required)	MDC: End Plate	005	A: Blocking Plate	20	Refer to ★

★ Design Standards: None Japanese Standard "JIS", European Design Standard and N. American Design Standard

MDC-005-A-20

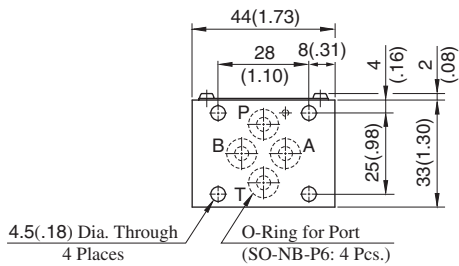

**DIMENSIONS IN
MILLIMETRES (INCHES)**

Approx. Mass.....0.3 kg(.66 lbs.)

Graphic Symbol



MDC-005-A

Base Plates For Modular Valves

Specifications

Max. Operating Pressure ----- 25 MPa (3630 PSI)



Model Number Designation

MMC	-005	-5	-20	*
Series Number	Plate Size	Number of Stations	Design Number	Design Standard
MMC: Base Plate	005	1 : 1 Station 2 : 2 Stations 3 : 3 Stations 4 : 4 Stations 5 : 5 Stations	20	None : Japanese Standard "JIS" 80 : European Design Standard 90 : N.American Design Standard

Instructions

- Port Used: Base plate has more than one pressure port "P" and tank port "T". Any one of these ports or two or more ports may be used. However, please note that the ports marked with (P) or (T) in the drawing are normally plugged. Remove the plugs when using such ports. Make sure that ports that are not currently used are properly plugged.

Graphic Symbols

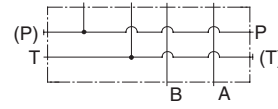

MMC-005-1

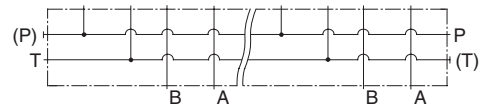

MMC-005-2-5

Pressure Drop

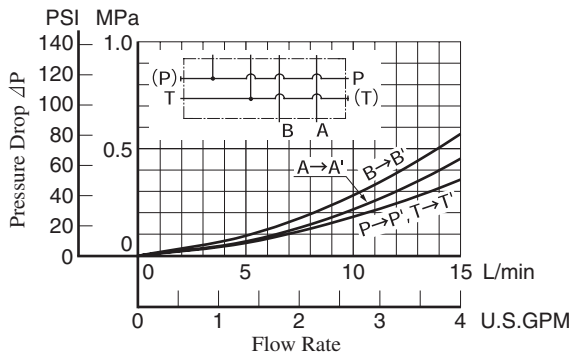

Mounting Surface Dimensions for 005 Series Modular Valve

When standard base plates (MMC-005) are not used, the mounting surface described on the right must be prepared. The mounting surface should have a good machined finish.

Design Std.	"C" Thd.	"E"
Japanese Std. "JIS" and European Design Std.	M4	7.5 (.30)
N. American Design Std.	No.8 - 32 UNC	10 (.39)

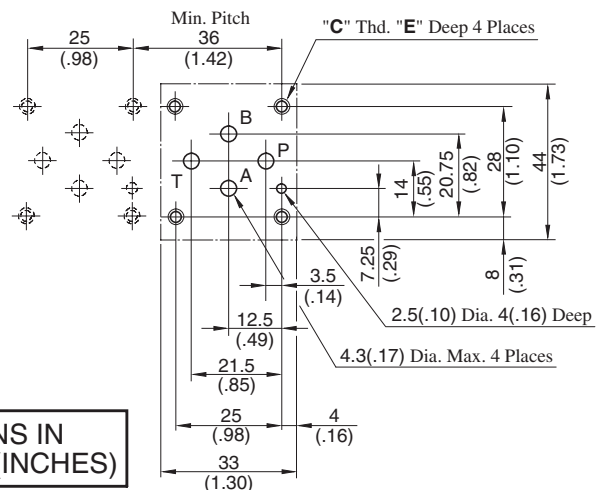

DIMENSIONS IN MILLIMETRES (INCHES)

005 Series Modular Valves

MMC-005-1-20/2090

DIMENSIONS IN MILLIMETRES (INCHES)

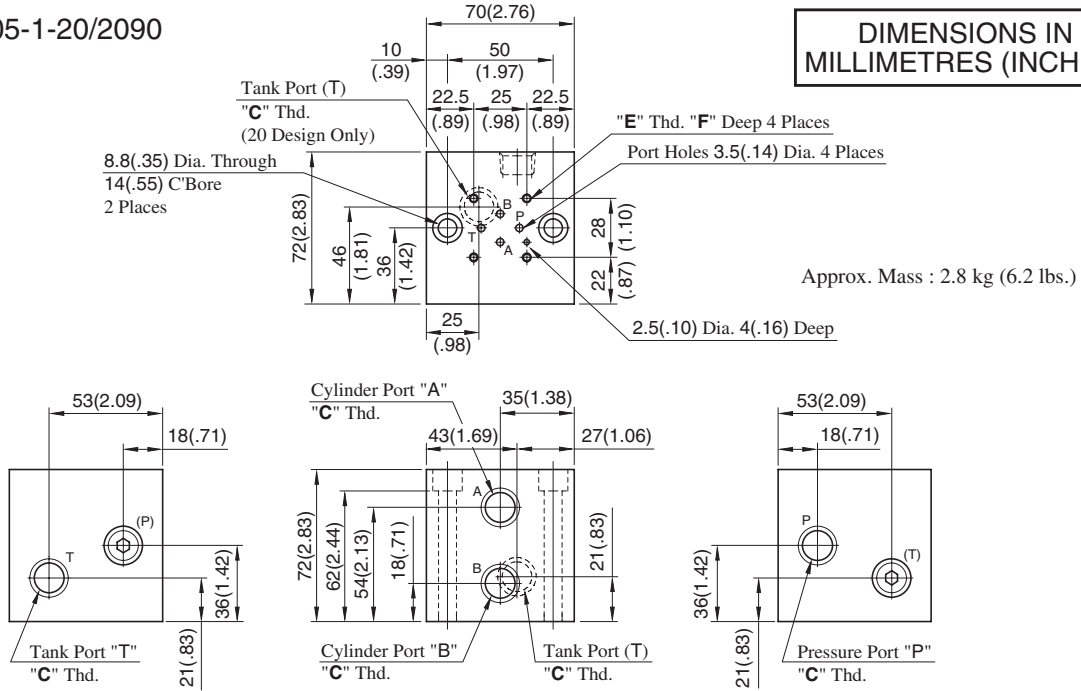

MMC-005-*-20/2090

Number of Station
(2-5 Stations)

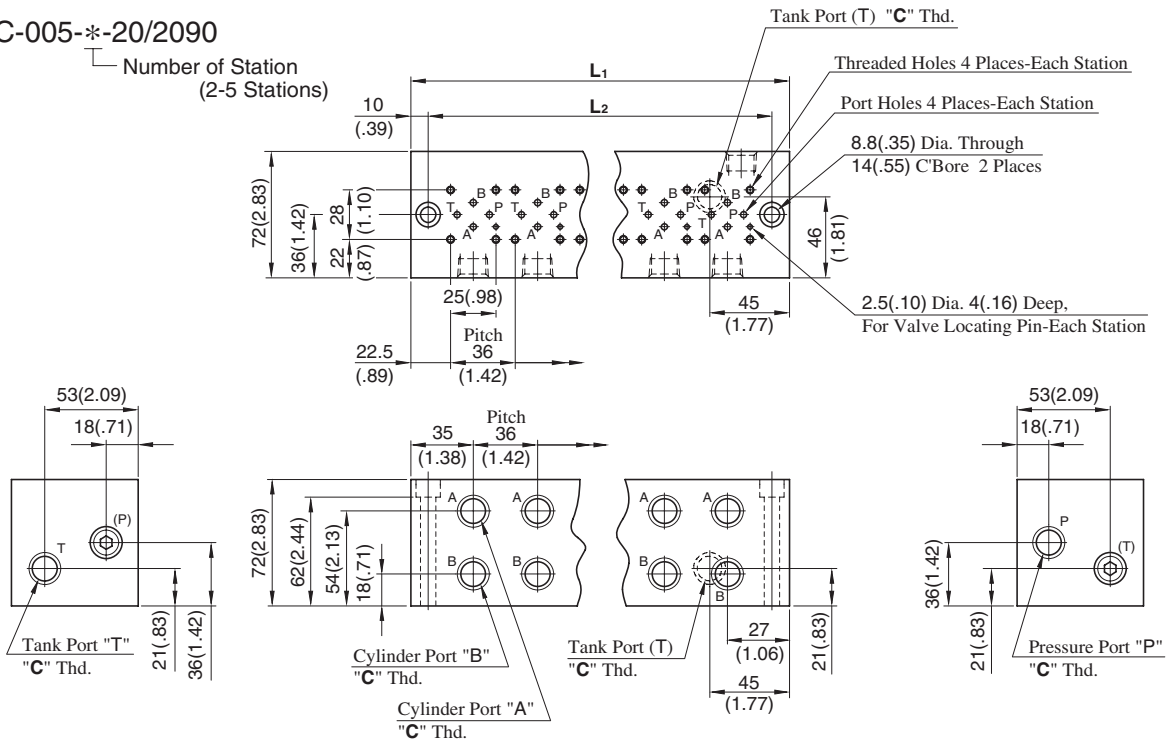

• For other dimensions, refer to the above Model MMC-005-1.

Model Numbers	Thread Size		Dimensions mm (Inches)
	"C" Thd.	"E" Thd.	F
MMC-005-*-20	Rc 3/8	M4	8 (.31)
MMC-005-*-2090	3/8 NPT	No. 8-32 UNC	10 (.39)

Model Numbers	Dimensions mm (Inches)		Approx. Mass kg (lbs.)
	L ₁	L ₂	
MMC-005-2	106 (4.17)	86 (3.39)	4.3 (9.5)
MMC-005-3	142 (5.59)	122 (4.80)	5.8 (12.8)
MMC-005-4	178 (7.01)	158 (6.22)	7.2 (15.9)
MMC-005-5	214 (8.43)	194 (7.64)	8.7 (19.2)

MMC-005-1-2080

DIMENSIONS IN MILLIMETRES (INCHES)

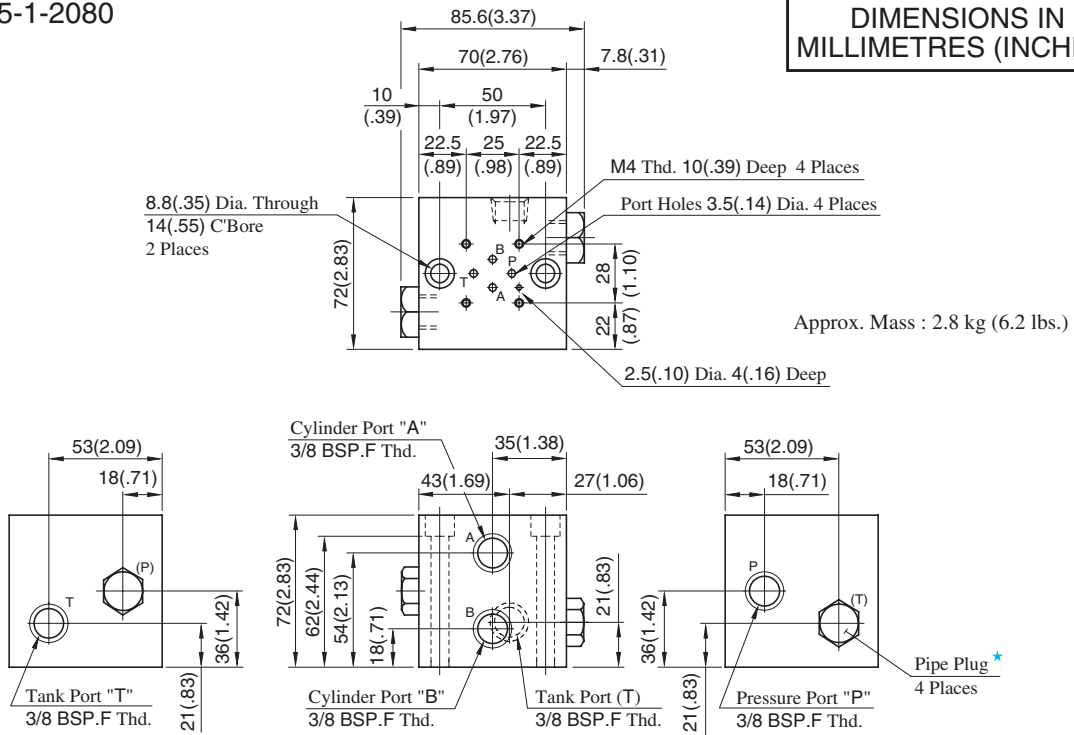

MMC-005-*2080

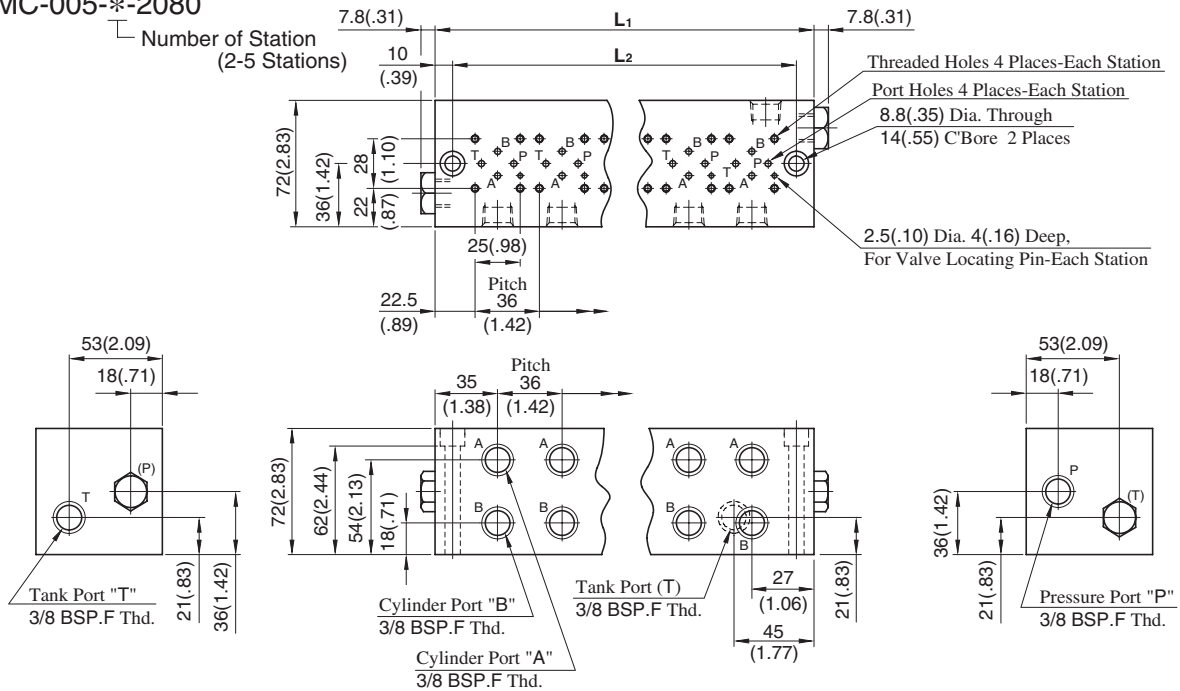

• For other dimensions, refer to the above Model MMC-005-1.

Model Numbers	Dimensions mm (Inches)		Approx. Mass kg (lbs.)
	L ₁	L ₂	
MMC-005-2	106 (4.17)	86 (3.39)	4.3 (9.5)
MMC-005-3	142 (5.59)	122 (4.80)	5.8 (12.8)
MMC-005-4	178 (7.01)	158 (6.22)	7.2 (15.9)
MMC-005-5	214 (8.43)	194 (7.64)	8.7 (19.2)

★ Detail of Pipe Plug

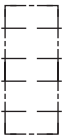
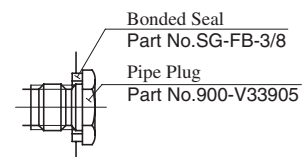

005 Series Modular Valves

Mounting Bolt Kits

To mount the valves, four M4 bolts are used. The combination of valves varies with circuits. So, we have several mounting bolt kits suitable for different valve combinations. From the selection chart, choose a necessary bolt kit and specify it with model number when ordering.



Model Number Designation

MBK	-005	-02	-20	*
Series Number	Size of Modular Valve	Bolt Number	Design Number	Design Standard
MBK: Bolt Kits for Modular Valves	005	01,02,03,05 (Refer to the following chart)	20	None: Japanese Standard "JIS" and European Design Standard 90: N.American Design Standard

Bolt Kits Selection Chart

Model Numbers	Quantity of valves to be stacked			Approx. Mass g (lbs.)
	Solenoid Operated Directional Valve (DSG-005)	Modular Valve (MDC-005)	Modular Valve (M**-005)	
MBK-005-01-20*	1	0	1	30(.07)
	0	1		
MBK-005-02-20*	1	0	2	40(.09)
	0	1		
MBK-005-03-20*	1	0	3	50(.11)
	0	1		
MBK-005-05-20*	1*	0	0	18(.04)
	0	1		

★ The solenoid operated directional valve comes with mounting bolts.

- **Bolts Kit Composition:**
Soc. Hd. Cap Screw.....4 Pcs.
- **Tightening Torque:**
2.5 - 3.5 Nm (22-31 in. lbs.)

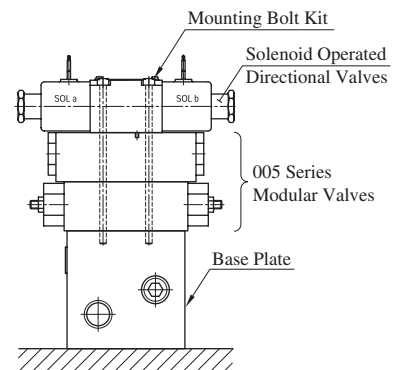

Stacking Example

MBK-005-*-20/2090

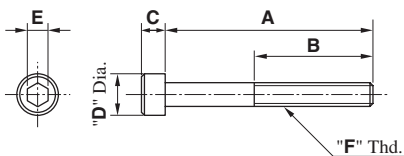

Model Numbers	Dimensions mm (Inches)					"F" Thd.
	A	B	C	D	E	
MBK-005-01-20	65 (2.56)	20 (.79)	4 (.16)	7 (.28)	3 (.12)	M4
MBK-005-02-20	95 (3.74)					
MBK-005-03-20	125 (4.92)					
MBK-005-05-20	35 (1.38)					
MBK-005-01-2090	65.1 (2-9/16)	22.4 (.88)	4.17 (.164)	6.86 (.27)	3.6 (9/64)	No. 8-32 UNC
MBK-005-02-2090	95.2 (3-3/4)					
MBK-005-03-2090	125.4 (4-15/16)					
MBK-005-05-2090	34.9 (1-3/8)					

1/8 Modular Valves

Type of Modular Valve

Class	Model Numbers	Graphic Symbols	Page	Class	Model Numbers	Graphic Symbols	Page
Pressure Control Valves	Solenoid Operated Directional Valve (S-)DSG-01-***-70/7090 E-DSG-01-***-D*60/6090 T-DSG-01-***-D24*70/7090 G-DSG-01-***-50/5090		344 378 379 412	Flow Control Valves	Throttle Valves (for "P-Line") MSP-01-50 Check and Throttle Valves (for "P-Line") MSCP-01-30 Throttle and Check Valves (for "A-Line", Metre-out) MSA-01-X-50 Throttle and Check Valves (for "A-Line", Metre-in) MSA-01-Y-50 Throttle and Check Valves (for "B-Line", Metre-out) MSB-01-X-50 Throttle and Check Valves (for "B-Line", Metre-in) MSB-01-Y-50 Throttle and Check Valves (for "A&B-Lines", Metre-out) MSW-01-X-50 Throttle and Check Valves (for "A&B-Lines", Metre-in) MSW-01-Y-50 Throttle and Check Valves (for "A&B-Lines", Metre-out, Metre-in) MSW-01-XY-50 Throttle and Check Valves (for "A&B-Lines", Metre-in, Metre-out) MSW-01-YX-50		559 561 563 563 563 563 563 563 563 563 563 563
	Relief Valves (for "P-Line") MBP-01-*30		536				
	Relief Valves (for "A-Line") MBA-01-*30		536				
	Relief Valves (for "B-Line") MBB-01-*30		536				
	Reducing Valves (for "P-Line") MRP-01-*30/3090		539				
	Reducing Valves (for "A-Line") MRA-01-*30/3090		539				
	Reducing Valves (for "B-Line") MRB-01-*30/3090		539				
	Brake Valves MBR-01-*30		542				
	Sequence Valves (for "P-Line") MHP-01-*30		544				
	Counterbalance Valves (for "A-Line") MHA-01-*30		544				
	Pressure Switch Valves (for "P-Line") MJP-01-*-*10		547				
	Pressure Switch Valves (for "A-Line") MJA-01-*-*10		547				
	Pressure Switch Valves (for "B-Line") MJB-01-*-*10		547				
Flow Control Valves	Flow Control Valves (for "P-Line") MFP-01-10		551	Directional Control Valves	Check Valves (for "P-Line") MCP-01-*30 Check Valves (for "T-Line") MCT-01-*30 Anti-Cavitation Valves MAC-01-30 Pilot Operated Check Valves (for "A-Line") MPA-01-*40/4001 Pilot Operated Check Valves (for "B-Line") MPB-01-*40/4001 Pilot Operated Check Valves (for "A&B-Lines") MPW-01-*40/4001		567 567 568 569 569 569
	Flow Control and Check Valves (for "A-Line", Metre-out) MFA-01-X-10		551				
	Flow Control and Check Valves (for "A-Line", Metre-in) MFA-01-Y-10		551				
	Flow Control and Check Valves (for "B-Line", Metre-out) MFB-01-X-10		551				
	Flow Control and Check Valves (for "B-Line", Metre-in) MFB-01-Y-10		551	Modular Plates and Mounting Bolts	End Plates (Blocking plates) MDC-01-A-30 End Plates (Bypass plates) MDC-01-B-30 Connecting Plates (for "P&A-Lines") MDS-01-PA-30/3090 Connecting Plates (for "P&B-Lines") MDS-01-PB-30/3090 Connecting Plates (for "A&T-Lines") MDS-01-AT-30/3090 Base Plates MMC-01-*40/4080/4090 Bolt Kits MBK-01-*30/3090		571 571 572 572 572 573 576
	Flow Control and Check Valves (for "A&B-Lines", Metre-out) MFW-01-X-10		551				
	Flow Control and Check Valves (for "A&B-Lines", Metre-in) MFW-01-Y-10		551				
	Temperature Compensated Throttle and Check Valves (for "A-Line", Metre-out) MSTA-01-X-10		555				
	Temperature Compensated Throttle and Check Valves (for "B-Line", Metre-out) MSTB-01-X-10		555				
	Temperature Compensated Throttle and Check Valves (for "A&B-Lines", Metre-out) MSTW-01-X-10		555				

Relief Modular Valves

Specifications

Model Numbers	Max. Operating Pressure MPa (PSI)	Max. Flow L/min (U.S.GPM)
MBP-01-*30 MBA-01-*30 MBB-01-*30	21 (3050)	35 (9.25)

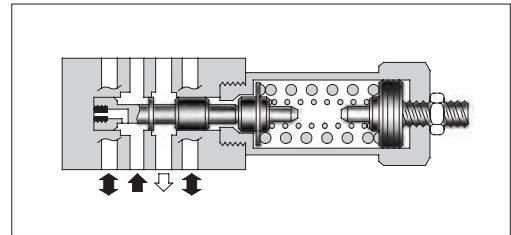

Model Number Designation

F-	MBP	-01	-C	-30	*
Special Seals	Series Number	Valve Size	Pres. Adj. Range MPa (PSI)	Design Number	Design Standard
F: Special Seals for Phosphate Ester Type Fluids (Omit if not required)	MBP: Relief Valve for P-Line MBA: Relief Valve for A-Line MBB: Relief Valve for B-Line	01	C: *-14 ^{★1} (*-2030) H: 7-21 (1020-3050)	30	Refer to ^{★2}

★1. See the "Minimum Adjustment Pressure" of the next page for the item marked *.

★2. Design Standards: None Japanese Standard "JIS", European Design Standard and N. American Design Standard

Instructions

- The minimum adjustment pressure equals the value obtained from the minimum adjustment pressure characteristics plus the tank line back pressure of the [next page](#). This back pressure should include the value of the T-line pressure drop characteristics of the valves stacked to the base plate side of the modular valve.
- To make pressure adjustment, loosen the lock nut and turn the pressure adjustment screw clockwise or anti-clockwise. For an increase of pressure, turn the screw clockwise. Be sure to re-tighten the lock nut firmly after making adjustment to the pressure.
- In case of a small flow, the setting pressure may become unstable. To avoid this, refer to the minimum flow characteristic curve of the next page and use the valve within a range as shown with .

Graphic Symbols

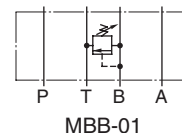
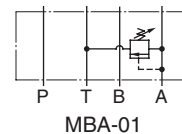
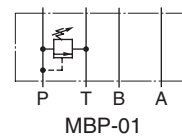

Typical Performance Characteristics

Hydraulic Fluid: Viscosity 35 mm²/s (164 SSU), Specific Gravity 0.850

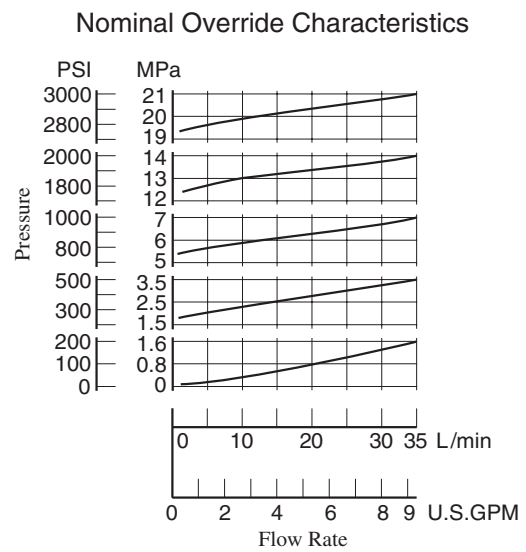
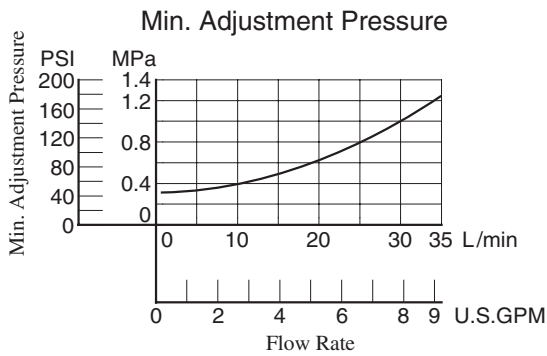
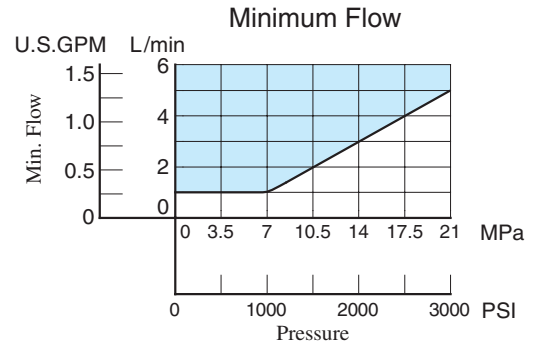
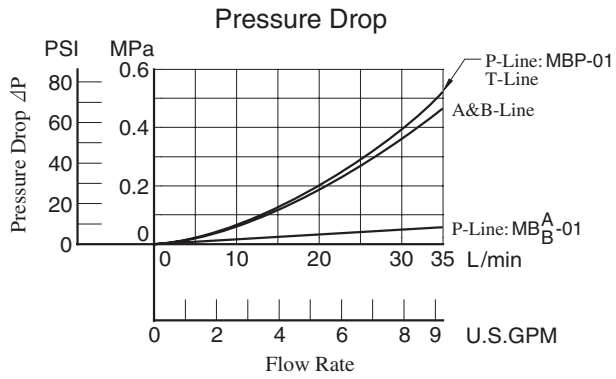

MBP-01-*-30

MBB-01-*-30

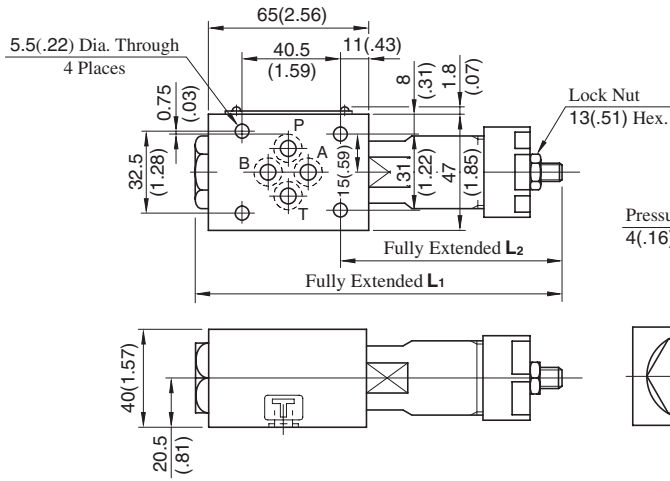

Model No.	L ₁	L ₂
MB*-01-C	151 (5.94)	92 (3.62)
MB*-01-H	166.5 (6.56)	107.5 (4.23)

Approx. Mass.....1.1 kg (2.4 lbs.)

DIMENSIONS IN MILLIMETRES (INCHES)

MBA-01-*-30

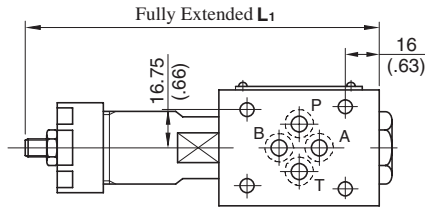

Approx. Mass.....1.1 kg (2.4 lbs.)

• For other dimensions, refer to above (MBP-01) drawing.

■ Spare Parts List

MBP-01-*-30

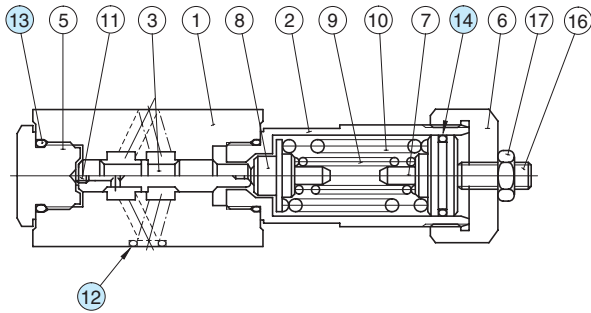

MBA-01-*-30

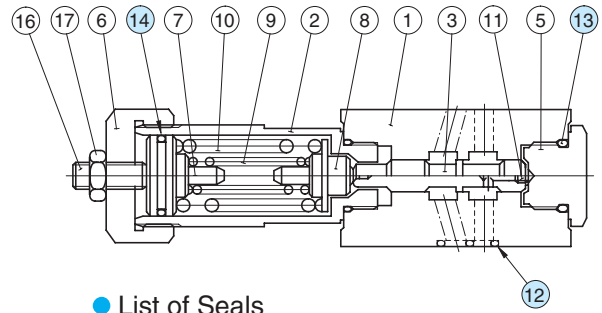

MBB-01-*-30

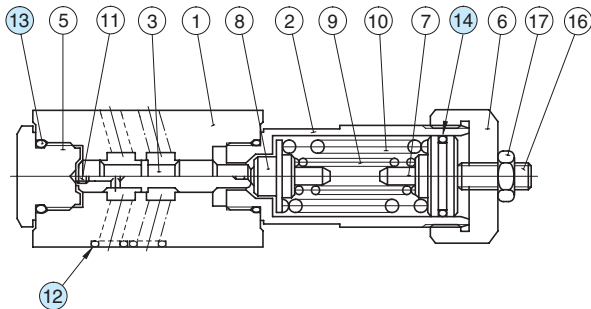

• List of Seals

Item	Name of Parts	Part Numbers	Qty.
12	O-Ring	SO-NB-P9	4
13	O-Ring	SO-NB-P18	2
14	O-Ring	SO-NA-P20	1

Note: When ordering seals, please specify the seal kit number from the table below.

• List of Seal Kit

Valve Model No.	Seal kit No.
MBP-01	KS-MBP-01-30
MBA-01	
MBB-01	

Reducing Modular Valves

Specifications

Model Numbers	Max. Operating Pressure MPa(PSI)	Max. Flow L/min (U.S.GPM)
MRP-01-*-30/3090 MRA-01-*-30/3090 MRB-01-*-30/3090	31.5 (4570)	35 (9.25) *

★ If the pressure is set below 1.9 MPa (280 PSI), the maximum flow is limited. See the minimum adjustment pressure vs. maximum flow characteristics and during use, stay within the shaded zone on the graph.

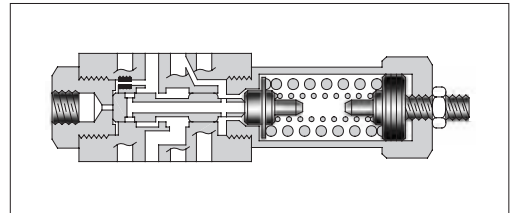
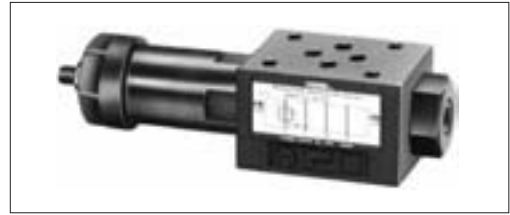

Model Number Designation

F-	MRP	-01	-B	-30	*
Special Seals	Series Number	Valve Size	Pres. Adj. Range MPa (PSI)	Design Number	Design Standard
F: Special Seals for Phosphate Ester Type Fluids (Omit if not required)	MRP : Reducing Valve for P-Line MRA : Reducing Valve for A-Line MRB : Reducing Valve for B-Line	01	B : *-7 (*-1020) *1 C : 3.5-14 (510-2030) H : 7-21 (1020-3050)	30	Refer to ★2

★1. See the "Minimum Adjustment Pressure vs. Maximum Flow" of the next page for the item marked *.

★2. Design Standards: None Japanese Standard "JIS" and European Design Standard
90 N. American Design Standard

Instructions

- The minimum adjustment pressure equals the value obtained from the minimum adjustment pressure characteristics plus the tank line back pressure of the next page. This back pressure should include the value of the T-line pressure drop characteristics of the valves stacked to the base plate side of the modular valve.
- To make pressure adjustment, loosen the lock nut and turn the pressure adjustment screw clockwise or anti-clockwise. For an increase of pressure, turn the screw clockwise. Be sure to re-tighten the lock nut firmly after making adjustment to the pressure.

Graphic Symbols

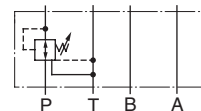

MRP-01

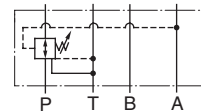

MRA-01

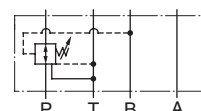

MRB-01

■ Typical Performance Characteristics

Hydraulic Fluid: Viscosity 35 mm²/s (164 SSU), Specific Gravity 0.850

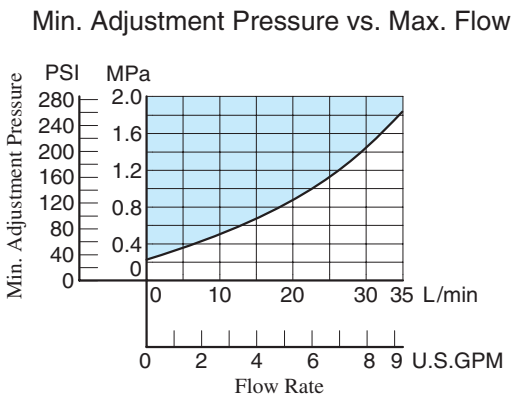
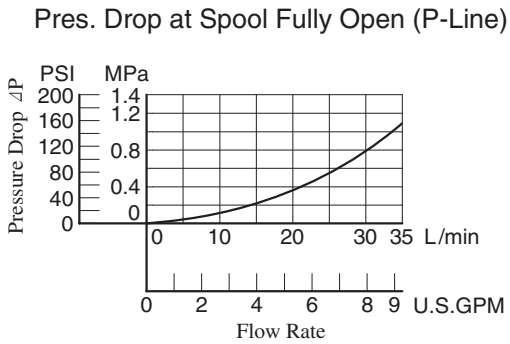
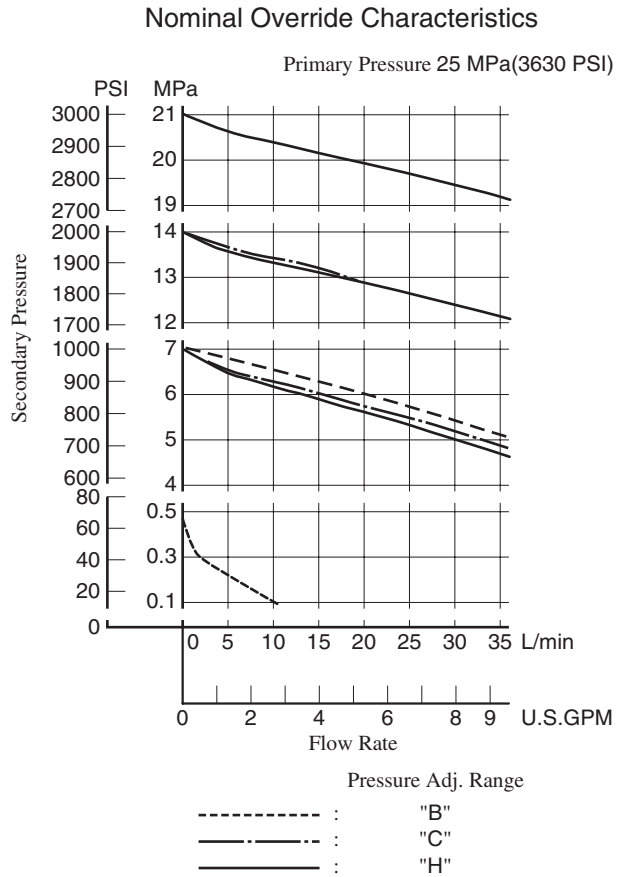
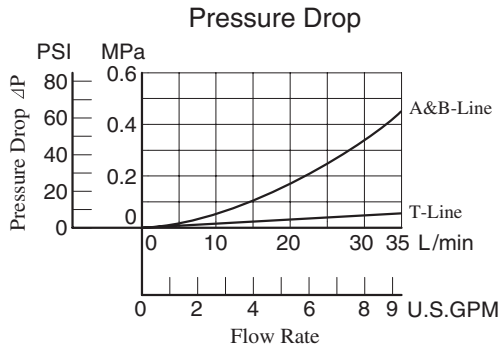

MRP-01-*-30/3090
MRA-01-*-30/3090
MRB-01-*-30/3090

DIMENSIONS IN
MILLIMETRES (INCHES)

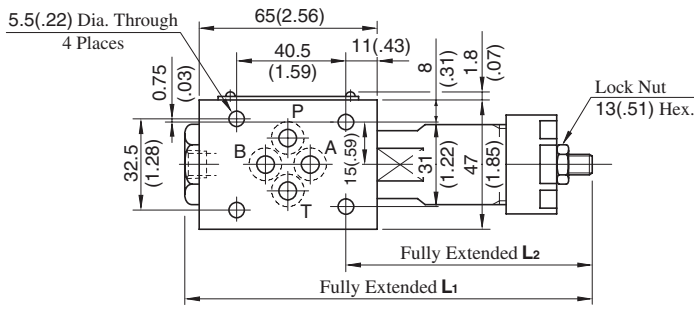

Model No.	L1	L2
MR*-01- ^B / _C	158 (6.22)	92 (3.62)
MR*-01-H	173.5 (6.83)	107.5 (4.23)

Pressure Gauge
Connection
"C" Thd.

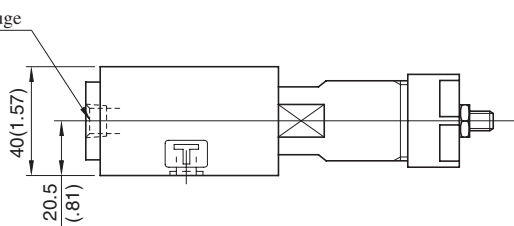

Pressure Adj. Screw
4(.16) Hex. Soc.

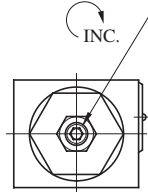

Model Numbers	Thread Size "C" Thd.
MR*-01-*-30	Rc 1/4 = 1/4 BSP.Tr
MR*-01-*-3090	1/4 NPT

Approx. Mass.....1.1 kg (2.4 lbs.)

Spare Parts List

MRP-01-*-30/3090
MRA-01-*-30/3090
MRB-01-*-30/3090

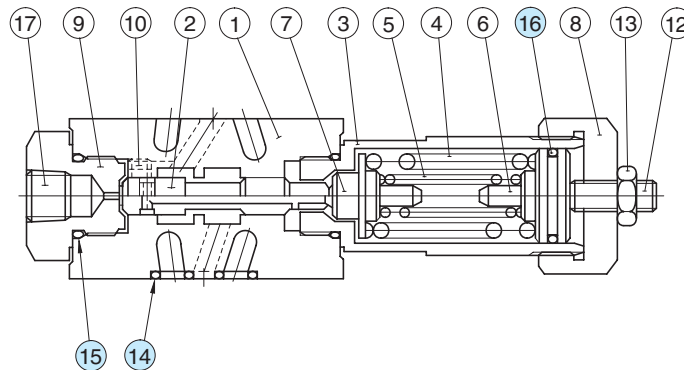

List of Seals

Item	Name of Parts	Part Numbers	Qty.	Remarks
14	O-Ring	SO-NB-P9	4	Included in Seal Kit Kit No.: KS-MBP-01-30
15	O-Ring	SO-NB-P18	2	
16	O-Ring	SO-NA-P20	1	

Brake Modular Valves

Specifications

Model Numbers	Max. Operating Pressure MPa (PSI)	Max. Flow L/min (U.S.GPM)
MBR-01-*-30	25 (3630)	35 (9.25)

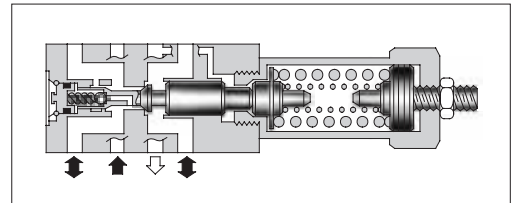

Model Number Designation

F-	MBR	-01	-C	-30	*
Special Seals	Series Number	Valve Size	Pres. Adj. Range MPa (PSI)	Design Number	Design Standard
F: Special Seals for Phosphate Ester Type Fluids (Omit if not required)	MBR: Brake Valve	01	C: *-14 * ¹ (*-2030) H: 7-21 (1020-3050)	30	Refer to * ²

★ 1. See the "Minimum Adjustment Pressure" for the item marked *.

★ 2. Design Standards: None..... Japanese Standard "JIS", European Design Standard and N. American Design Standard

Typical Performance Characteristics

Hydraulic Fluid: Viscosity 35 mm²/s (164 SSU), Specific Gravity 0.850

Graphic Symbol

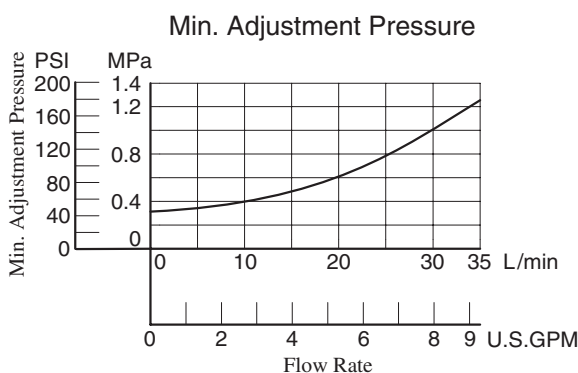
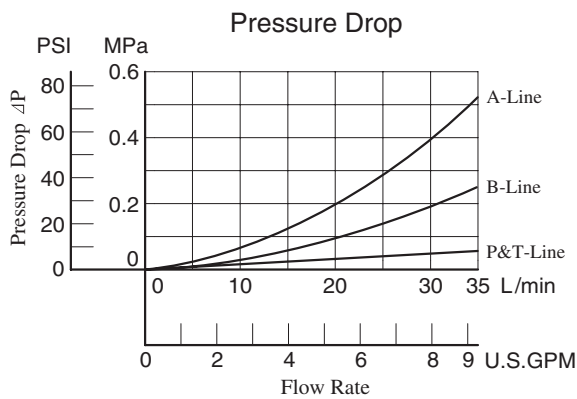
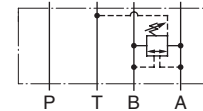

Instructions

- The minimum adjustment pressure equals the value obtained from the minimum adjustment pressure characteristics plus the tank line back pressure of the left. This back pressure should include the value of the T-line pressure drop characteristics of the valves stacked to the base plate side of the modular valve.
- To make pressure adjustment, loosen the lock nut and turn the pressure adjustment screw clockwise or anti-clockwise. For an increase of pressure, turn the screw clockwise. Be sure to re-tighten the lock nut firmly after making adjustment to the pressure.

MBR-01-*-30

DIMENSIONS IN
MILLIMETRES (INCHES)

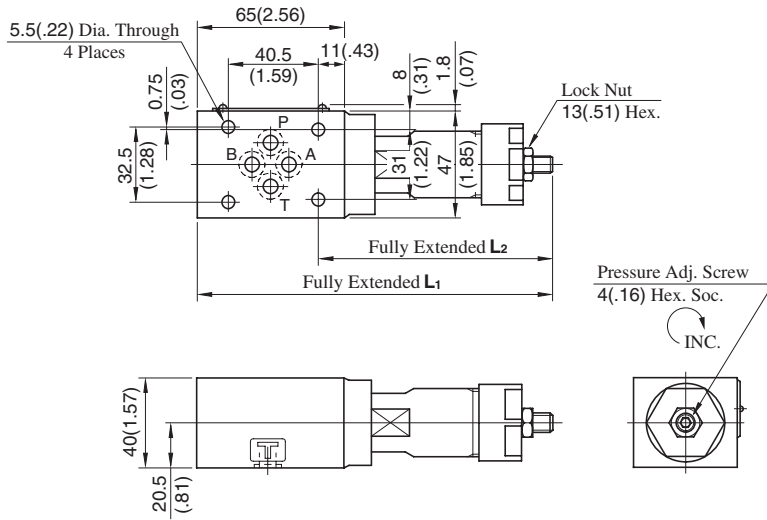

Model No.	L ₁	L ₂
MBR-01-C	161 (6.34)	107 (4.21)
MBR-01-H	176.5 (6.95)	122.5 (4.82)

Approx. Mass.....1.3 kg (2.9 lbs.)

Spare Parts List

MBR-01-*-30

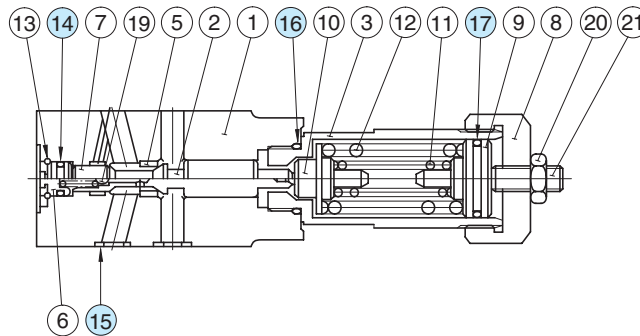

List of Seals

Item	Name of Parts	Part Numbers	Qty.	Remarks
14	O-Ring	SO-NB-P7	1	Included in Seal Kit Kit No.: KS-MBR-01-30
15	O-Ring	SO-NB-P9	4	
16	O-Ring	SO-NB-P18	1	
17	O-Ring	SO-NA-P20	1	

Sequence Modular Valves/Counterbalance Modular Valves

Specifications

Model Numbers	Max. Operating Pressure MPa (PSI)	Max. Flow L/min (U.S.GPM)	Free Flow L/min (U.S.GPM)
MHP-01-* -30	25 (3630)	35 (9.25)	—
MHA-01-* -30			35 (9.25)



Graphic Symbols

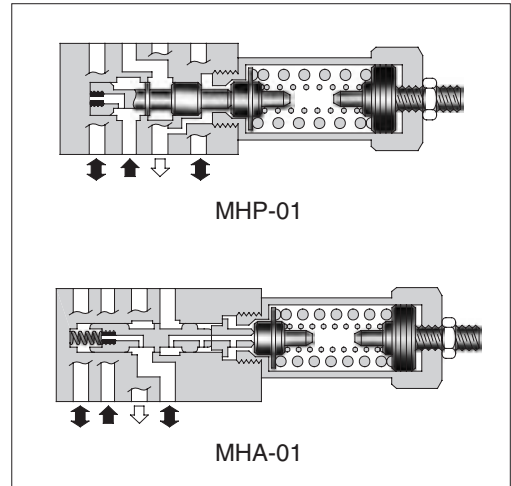
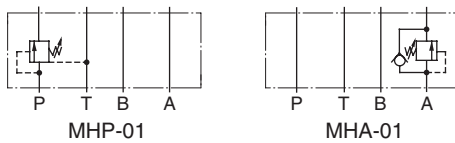

Model Number Designation

F-	MHP	-01	-C	-30	*
Special Seals	Series Number	Valve Size	Pres. Adj. Range MPa (PSI)	Design Number	Design Standard
F: Special Seals for Phosphate Ester Type Fluids (Omit if not required)	MHP: Sequence Valve for P-Line MHB: Counterbalance Valve for A-Line	01	C: *-14 * ¹ (*-2030) H: 7-21 (1020-3050)	30	Refer to * ²

*¹ See the "Minimum Adjustment Pressure" of the next page for the item marked *.

*² Design Standards: None Japanese Standard "JIS", European Design Standard and N. American Design Standard

Instructions

- The minimum adjustment pressure (MHP-01) equals the value obtained from the minimum adjustment pressure characteristics plus the tank line back pressure of the next page. This back pressure should include the value of the T-line pressure drop characteristics of the valves stacked to the base plate side of the modular valve.
- To make pressure adjustment, loosen the lock nut and turn the pressure adjustment screw clockwise or anti-clockwise. For an increase of pressure, turn the screw clockwise. Be sure to re-tighten the lock nut firmly after making adjustment to the pressure.
- The minimum adjustment pressure (MHA-01) equals the value obtained from the minimum adjustment pressure characteristics plus the outlet-side back pressure of the valve on the next page. The outlet-side back pressure should include the values of the A-line and T-line pressure drop characteristics of the valves to be stacked due to the valve with internal drain.

Typical Performance Characteristics

Hydraulic Fluid: Viscosity $35 \text{ mm}^2/\text{s}$ (164 SSU), Specific Gravity 0.850

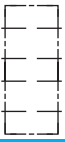
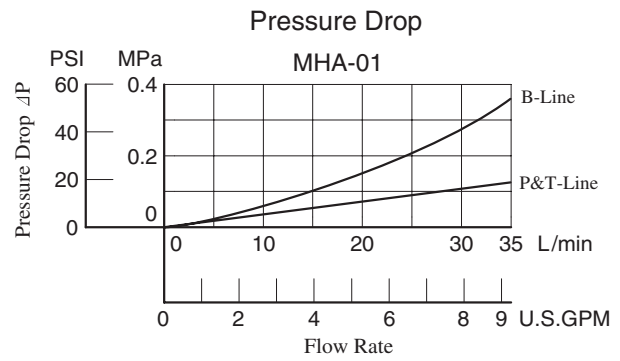
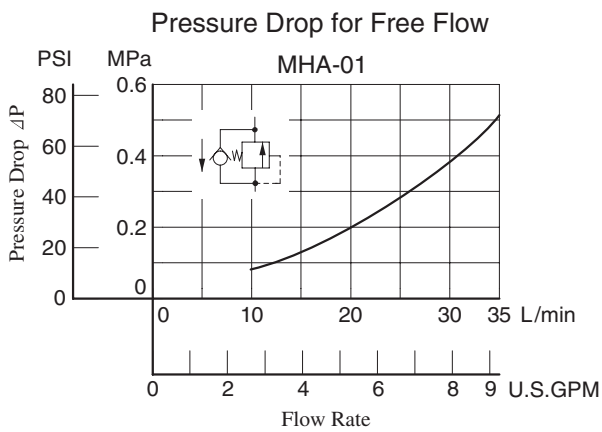
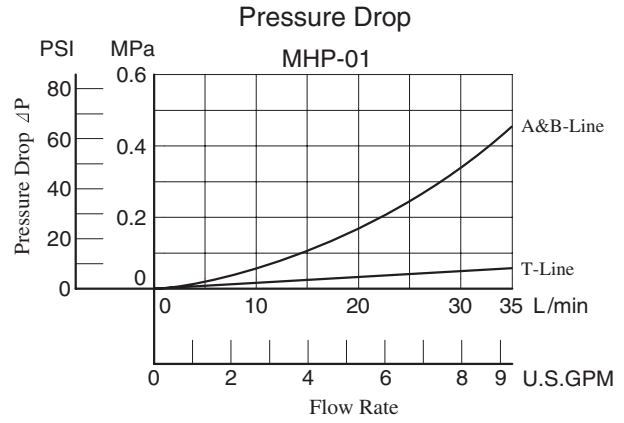
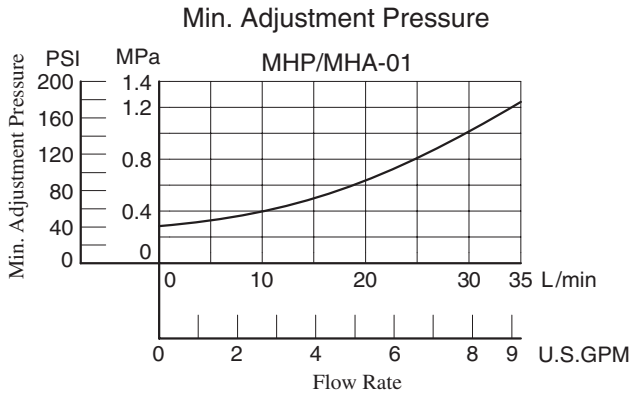

MHP-01-*-30

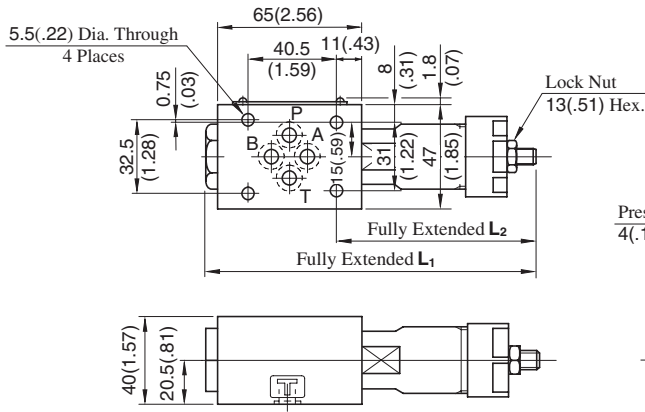

Model Numbers	L ₁	L ₂
MHP-01-C	151 (5.94)	92 (3.62)
MHP-01-H	166.5 (6.56)	107.5 (4.23)

Approx. Mass.....1.1 kg (2.4 lbs.)

DIMENSIONS IN MILLIMETRES (INCHES)

MHA-01-*-30

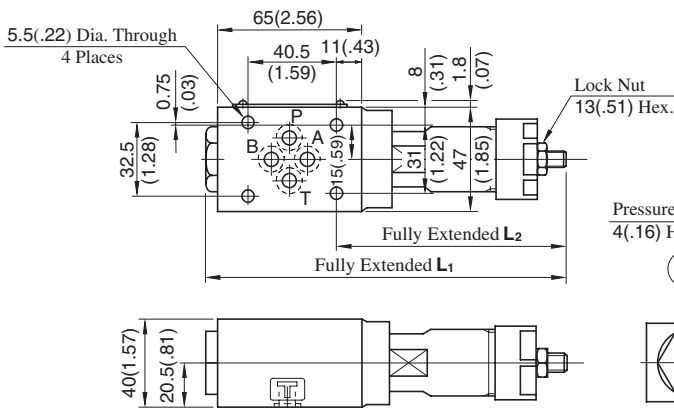

Model Numbers	L ₁	L ₂
MHA-01-C	171 (6.73)	112 (4.41)
MHA-01-H	186.5 (7.34)	127.5 (5.02)

Approx. Mass.....1.3 kg (2.9 lbs.)

■ Spare Parts List

MHP-01-*-30

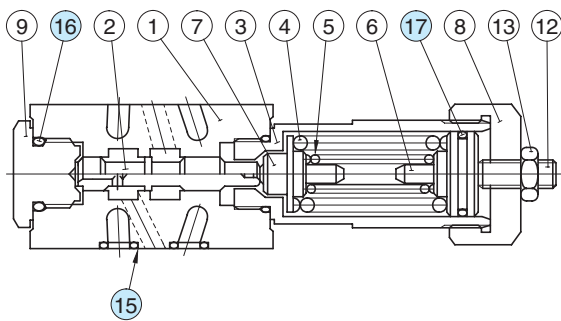

● List of Seals

Item	Name of Parts	Part Numbers	Qty.	Remarks
15	O-Ring	SO-NB-P9	4	Included in Seal Kit Kit No.: KS-MBP-01-30
16	O-Ring	SO-NB-P18	2	
17	O-Ring	SO-NA-P20	1	

MHA-01-*-30

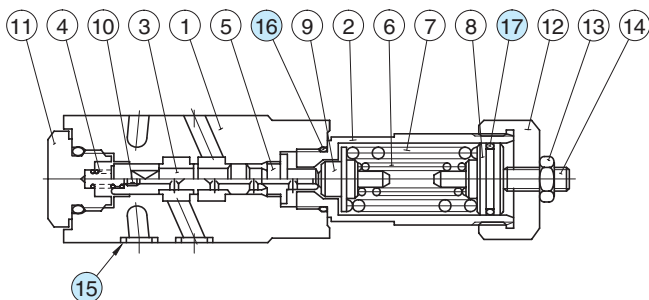

● List of Seals

Item	Name of Parts	Part Numbers	Qty.	Remarks
15	O-Ring	SO-NB-P9	4	Included in Seal Kit Kit No.: KS-MHA-01-30
16	O-Ring	SO-NB-P18	2	
17	O-Ring	SO-NB-P20	1	

Pressure Switch Modular Valves

Specifications

Model Numbers	Max. Operating Pressure MPa(PaSI)	Max. Flow L/min (U.S.GPM)
MJ*-01-M-*-*-10	31.5 (4570)	35 (9.25)
MJ*-01-J-35-10	10 (1450)	
MJ*-01-J-100-10	10 (1450)	
MJ*-01-J-200-10	20 (2900)	
MJ*-01-J-350-10	35 (5080)	

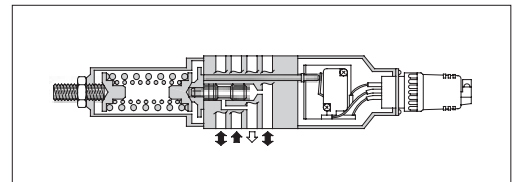

Sensitive Switch Ratings

Electric Source		AC	DC	
Voltage	V	125 • 250	125	250
Current	A	11A-1/3HP	0.5	0.25

Specifications of semiconductor type pressure switch

JT-02 series is installed for semiconductor type pressure switch, refer to [page 272](#) for details.

Model Number Designation

F-	MJP	-01	-M	-B	-N	-10	*
Special Seals	Series Number	Valve Size	Type of Switch	Pres. Adj. Range MPa (PSI)	Type of Electrical Connection	Design Number	Design Standard
F: Special Seals for Phosphate Ester Type Fluids (Omit if not required)	MJP : Pressure Switch for P-Line	01	M: Sensitive Switch	B: 1-7 (145-1020) C: 3.5-14 (510-2030) H: 7-21 (1020-3050)	None: Cable Connector Type N: With Plug-in Connector (DIN)	10	Refer to ★
	MJA : Pressure Switch for A-Line		J: Semi-conductor Type Pressure Switch	35: 0.1-3.5 (14.5-510) 100: 1-10 (145-1450) 200: 2-20 (290-2900) 350: 3.5-35 (510-5080)	None: Lead Wire Type		
MJB : Pressure Switch for B-Line							

★ Design Standards: None Japanese Standard "JIS", European Design Standard and N. American Design Standard

Graphic Symbols

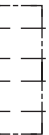
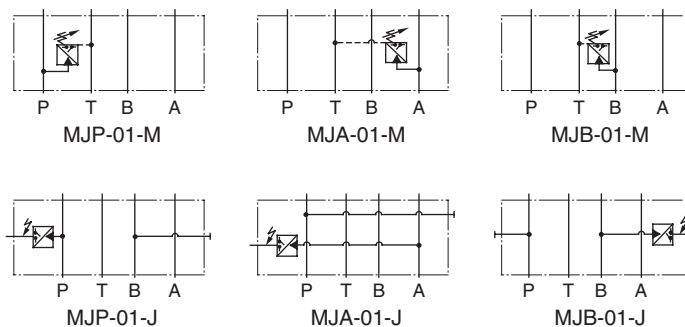

Instructions

- To make pressure adjustment, loosen the lock nut and turn the pressure adjustment screw clockwise or anti-clockwise. For an increase of pressure, turn the screw clockwise. Be sure to re-tighten the lock nut firmly after making adjustment to the pressure.
- Wiring of a sensitive switch should be made correctly referring to the table below. Numbers in the switch status column indicate wiring numbers in receptacles or contact numbers of connectors.

(Pressure with Sensitive Switch)
and The Switch Status

Operating Pressure	Switch Status
Less than Pressure setting	1 ○ 2 ○ 3
More than Pressure setting	1 ○ 2 ○ 3

Attachment

Valve Model No.	Attachment
MJ*-01-M-*-10	Cable connector: NJC-203-PR 1 Pc.
MJ*-01-M-*-N-10	DIN connector: GDM311-B-11... 1 Pc.

Pressure Drop

Hydraulic Fluid: Viscosity 35 mm²/s (164 SSU), Specific Gravity 0.850

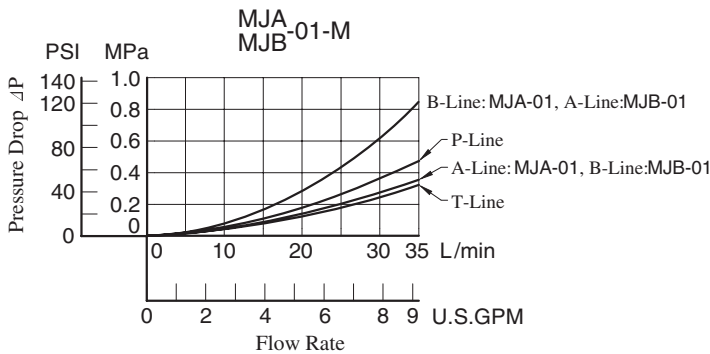
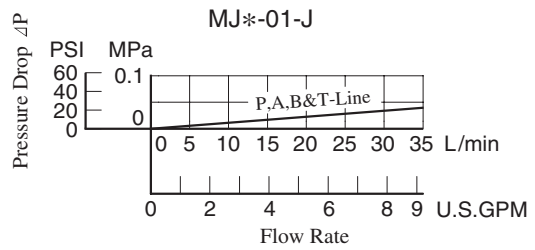
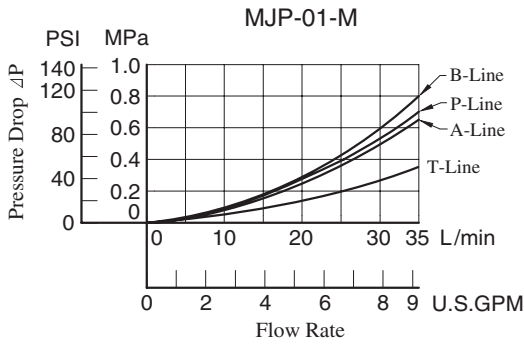

● Cable Connector Type

MJP-01-M-*-10
MJA-01-M-*-10

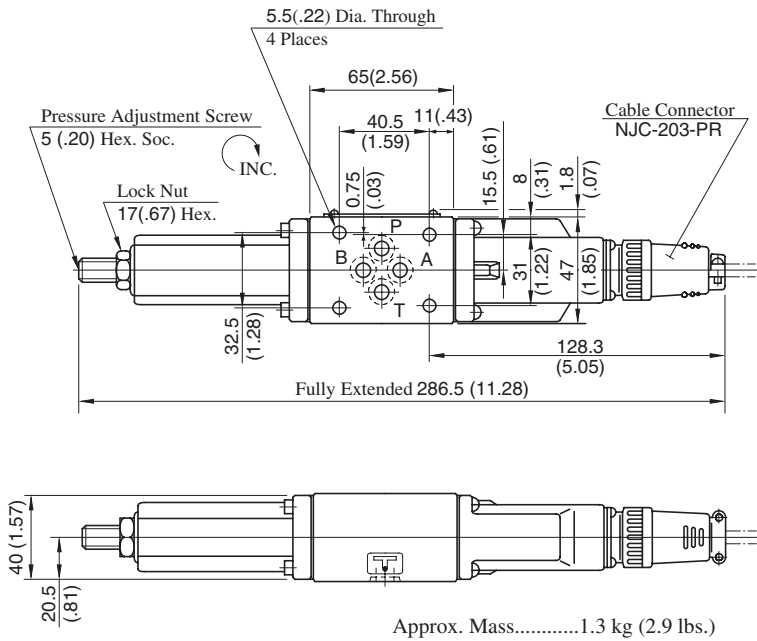

MJB-01-M-*-10

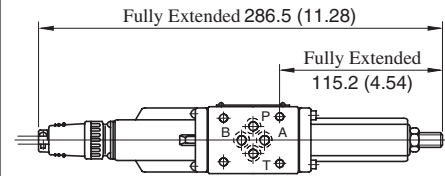

Approx. Mass.....1.3 kg (2.9 lbs.)

- For other dimensions, refer to "MJ_A^P-01" drawing left.

● Plug-in Connector Type

MJP-01-M-*-N-10
MJA-01-M-*-N-10

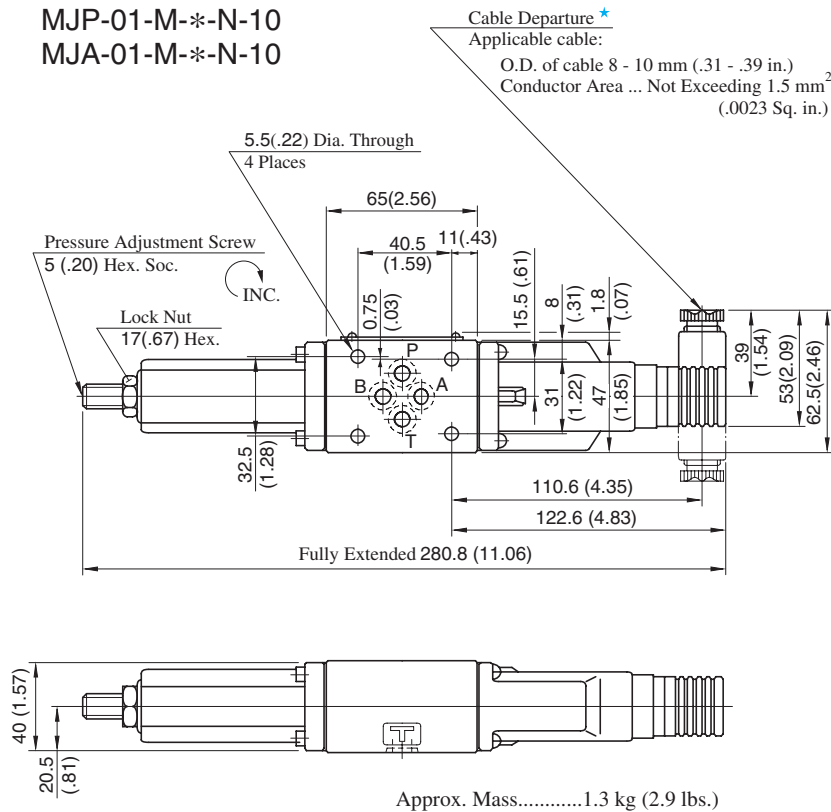

DIMENSIONS IN
MILLIMETRES (INCHES)

MJB-01-M-*-N-10

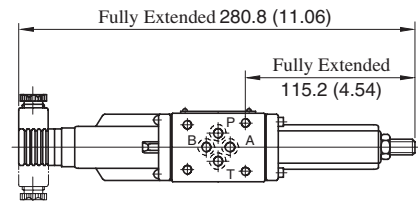

Approx. Mass.....1.3 kg (2.9 lbs.)

- For other dimensions, refer to "MJ_A^P-01" drawing left.

★ As shown by the dot-and-dash line, the cable departure can also be faced opposite.

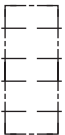

01 Series Modular Valves

● Semiconductor Type Pressure Switch

MJP-01-J-*-10

MJA-01-J-*-10

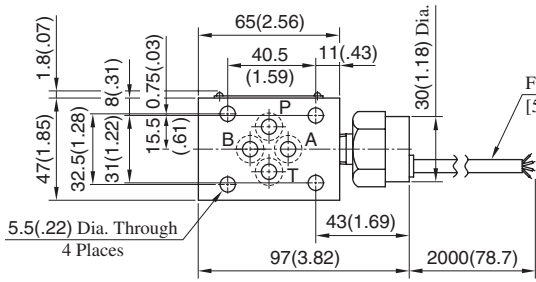

Four Conductor Cable
[5 mm(.20 in.) O.D.]
RED-----Power Supply ⊕
BLACK---Power Supply ⊖
WHITE---Output ⊕
GREEN---Output ⊖

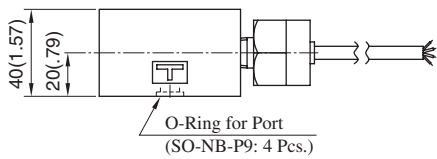
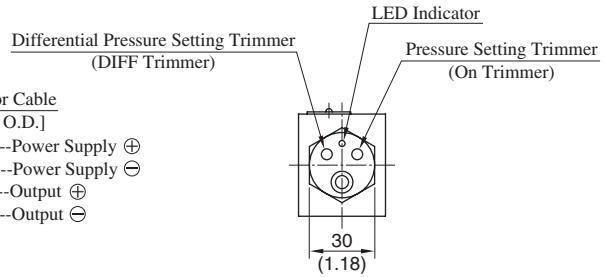

Approx. Mass.....1 kg (2.2 lbs.)

MJB-01-J-*-10

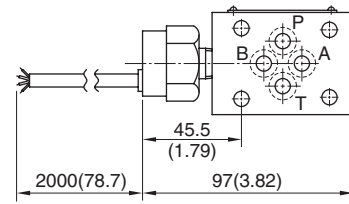

Approx. Mass.....1 kg (2.2 lbs.)

● For other dimensions, refer to "MJ_A^P-01" drawing left.

■ Spare Parts List

● Plug-in Connector Type

MJP
MJA-01-M-*-N-10
MJB

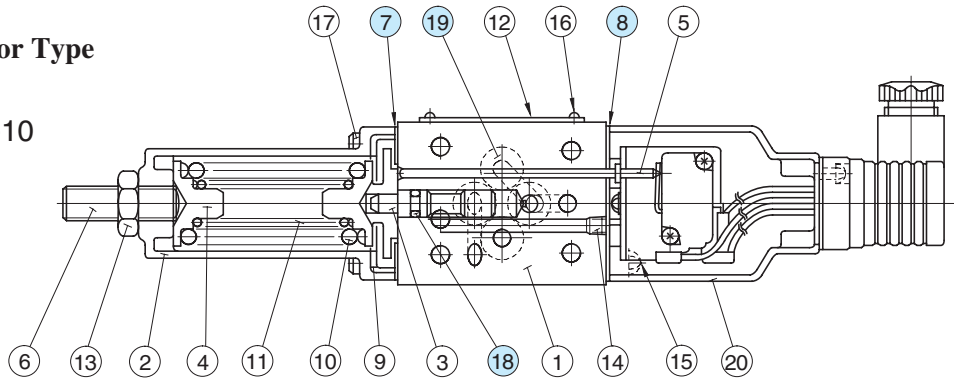

● Cable Connector Type

MJP
MJA-01-M-*-10
MJB

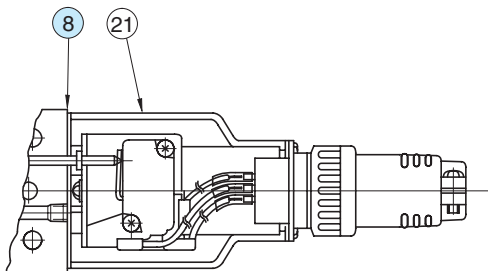

● List of Seals

Item	Name of Parts	Part Numbers	Qty.
7	Packing	3116-VK414239-4	1
8	Packing	3116-VK414240-2	1
18	O-Ring	SO-NA-P5	1
19	O-Ring	SO-NB-P9	4

Note: When ordering seals, please specify the seal kit number from the table below.

● List of Seal Kits

Valve Model No.	Seal Kit Numbers
MJP-01	Included in seal kit Kit No.: KS-MJP-01-10
MJA-01	
MJB-01	

● Since MJ*-01-J-*-10 (Semiconductor type pressure switch) does not have any seals inside, only four(4) O-rings for the ports are required. Please refer to the above drawing.

Pressure and Temperature Compensated Flow Control (and Check) Modular Valves

Specifications

Model Numbers	Max. Operating Pressure MPa (PSI)	Max. Metred Flow L/min (U.S.GPM)	Max. Free Flow L/min (U.S.GPM)
MFP-01-10	16 (2320)	35 (9.25)	—
MFA-01-*-10			35 (9.25)
MFB-01-*-10 MFW-01-*-10			

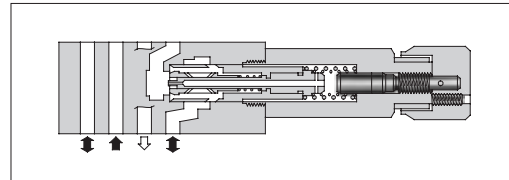

Model Number Designation

F-	MFA	-01	-X	-10	
Special Seals	Series Number	Valve Size	Direction of Flow	Design Number	Design Standard
F: Special Seals for Phosphate Ester Type Fluids (Omit if not required)	MFP : Flow Control Valve for P-Line	01	—	10	Refer to ★
	MFA : Flow Control and Check Valve for A-Line		X : Metre-out Y : Metre-in	10	
	MFB : Flow Control and Check Valve for B-Line MFW : Flow Control and Check Valve for A&B-Lines				

★ Design Standards: None Japanese Standard "JIS", European Design Standard and N. American Design Standard

Instructions

- To make flow rate adjustment, loosen locking screw for the dial and turn the flow adjustment dial clockwise or anti-clockwise. For a decrease of flow, turn the dial clockwise. Be sure to re-tighten the locking screw firmly after the adjustment of the flow rate.

Graphic Symbols

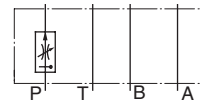

MFP-01

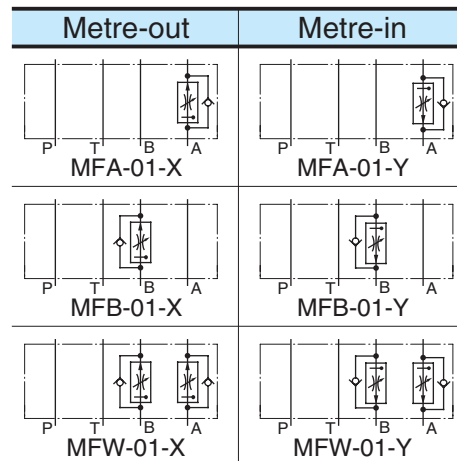

Typical Performance Characteristics

Hydraulic Fluid: Viscosity 35 mm²/s (164 SSU), Specific Gravity 0.850

Min. Required Pressure Difference

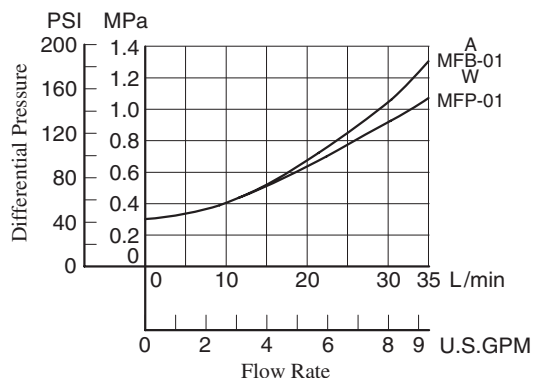

Metred Flows vs. Dial Position

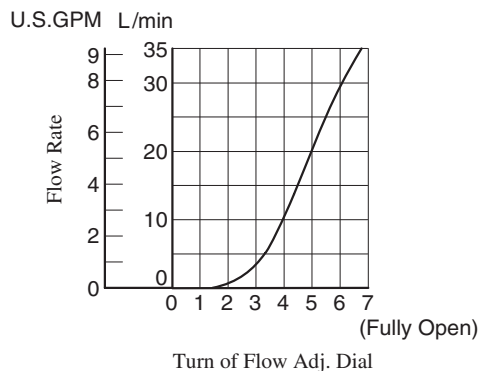

Min. Metred Flow

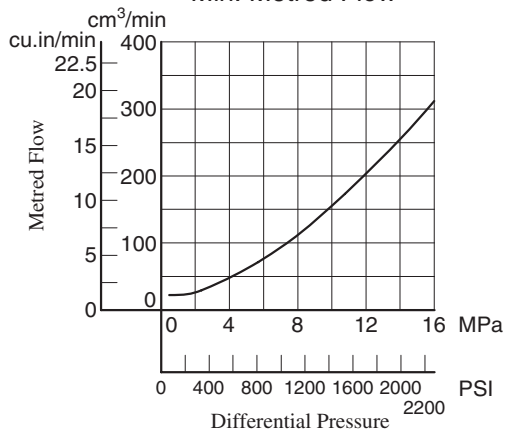

Metred Flow vs. Viscosity

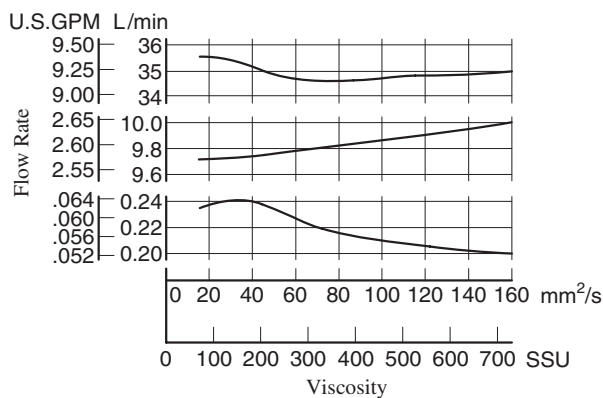

Pressure Drop

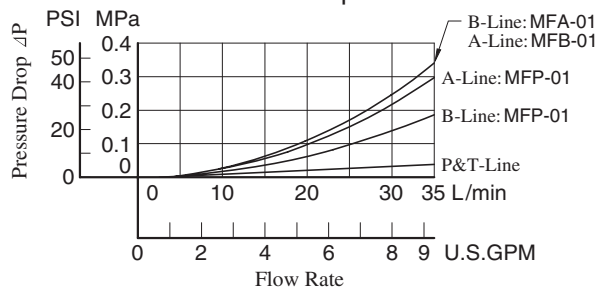

Metred Flow vs. Differential Pres.

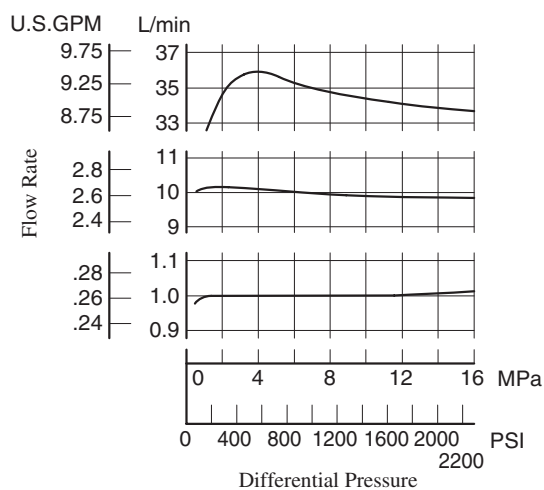

Pressure Drop for Free Flow

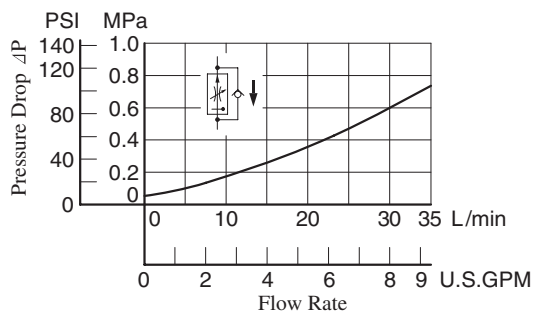

MFP-01-10

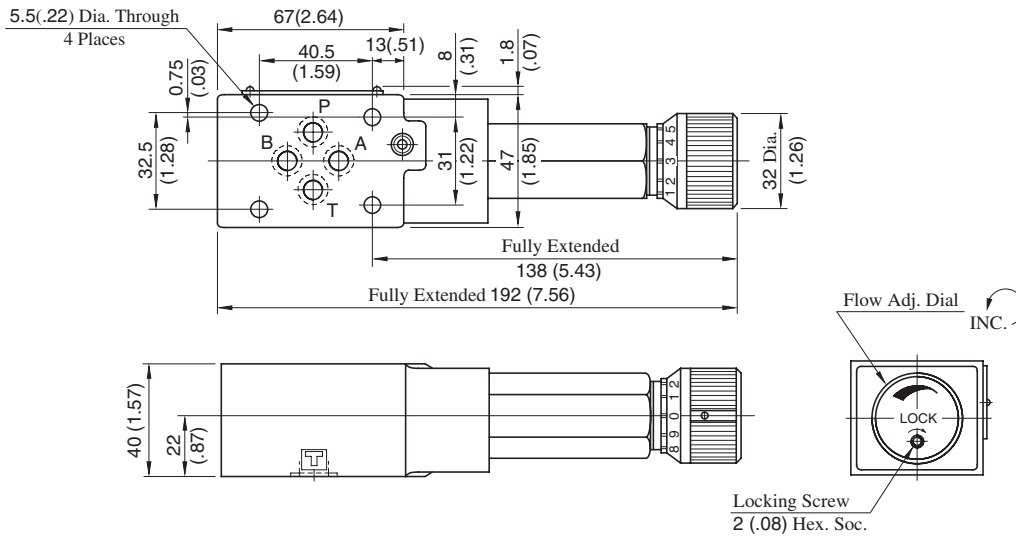

Approx. Mass..... 1.7 kg (3.8 lbs.)

MFW-01-X-10

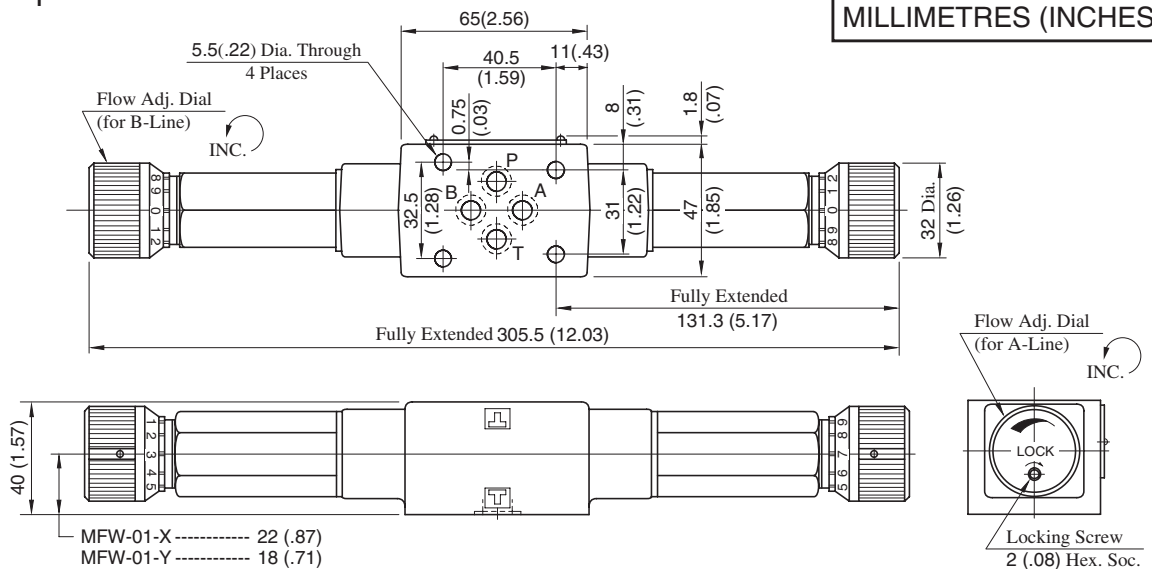

DIMENSIONS IN
MILLIMETRES (INCHES)

Approx. Mass..... 2.1 kg (4.6 lbs.)

MFA-01-X-10

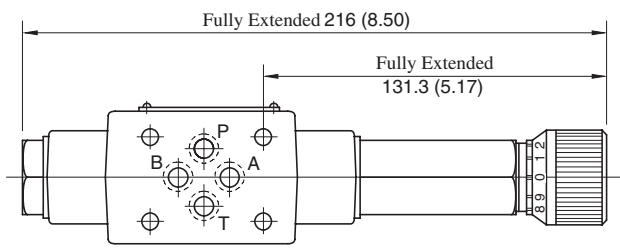

Approx. Mass..... 1.6 kg (3.5 lbs.)

MFB-01-X-10

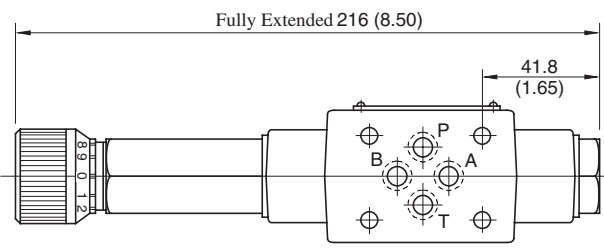

Approx. Mass..... 1.6 kg (3.5 lbs.)

• For other dimensions, refer to "MFW-01" drawing above.

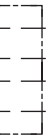

01 Series Modular Valves

■ Spare Parts List

MFP-01-10

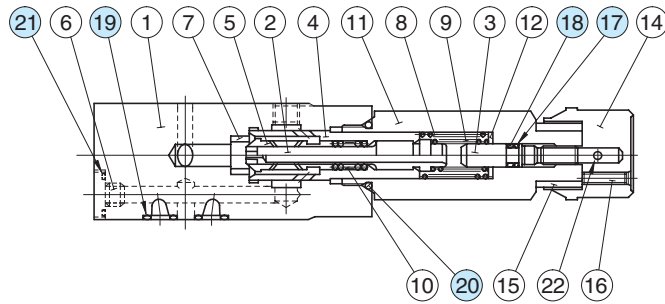

MFW-01-X_Y-10

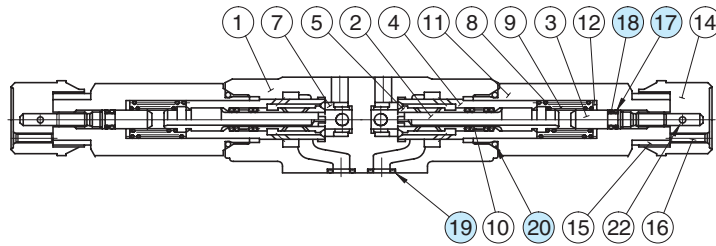

MFA-01-X_Y-10

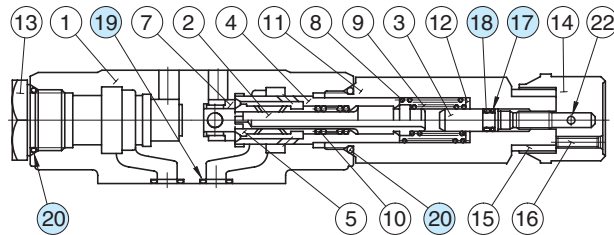

MFB-01-X_Y-10

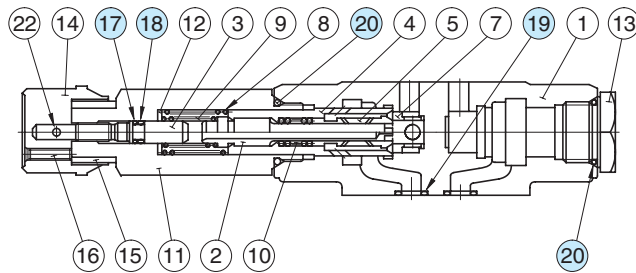

● List of Seals

Item	Name of Parts	Part Numbers	Quantity			
			MFP-01	MFA-01	MFB-01	MFW-01
17	Back Up Ring	SO-BB-P6	1	1	1	2
18	O-Ring	SO-NA-P6	1	1	1	2
19	O-Ring	SO-NB-P9	4	4	4	4
20	O-Ring	SO-NB-P18	1	2	2	2
21	O-Ring	SO-NB-P10	1	—	—	—

● List of Seal Kits

Valve Model Numbers	Seal Kit Numbers
MFP-01	KS-MFP-01-10
MFA-01	KS-MFA-01-10
MFB-01	
MFW-01	KS-MFW-01-10

Note: When ordering seals, please specify the seal kit number from the table right.

Temperature Compensated Throttle and Check Modular Valves

Specifications

Model Numbers	Max. Operating Pressure	Max. Differential Pressure	Max. Metred Flow	Min. Metred Flow	Max. Free Flow
	MPa (PSI)	MPa (PSI)	L/min (U.S.GPM)	L/min (U.S.GPM)	L/min (U.S.GPM)
MSTA-01-X-10	31.5 (4570)	14 (2030)	35 (9.25)	0.5 (.13)	35 (9.25)
MSTB-01-X-10					
MSTW-01-X-10					

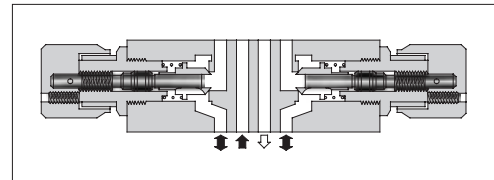

Model Number Designation

F-	MSTA	-01	-X	-10	*
Special Seals	Series Number	Valve Size	Direction of Flow	Design Number	Design Standard
F: Special Seals for Phosphate Ester Type Fluids (Omit if not required)	MSTA : Temperature Compensated Throttle and Check Valve for A-Line MSTB : Temperature Compensated Throttle and Check Valve for B-Line MSTW : Temperature Compensated Throttle and Check Valve for A&B-Lines	01	X : Metre-out	10	Refer to ★

★ Design Standards: None Japanese Standard "JIS", European Design Standard and N. American Design Standard

Instructions

- To make flow rate adjustment, loosen locking screw for the dial and turn the flow adjustment dial clockwise or anti-clockwise. For a decrease of flow, turn the dial clockwise. Be sure to re-tighten the locking screw firmly after the adjustment of the flow rate.

Graphic Symbols

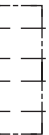
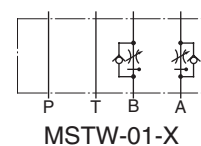
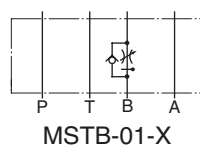
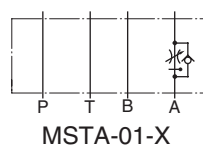

Typical Performance Characteristics

Hydraulic Fluid: Viscosity 35 mm²/s (164 SSU), Specific Gravity 0.850

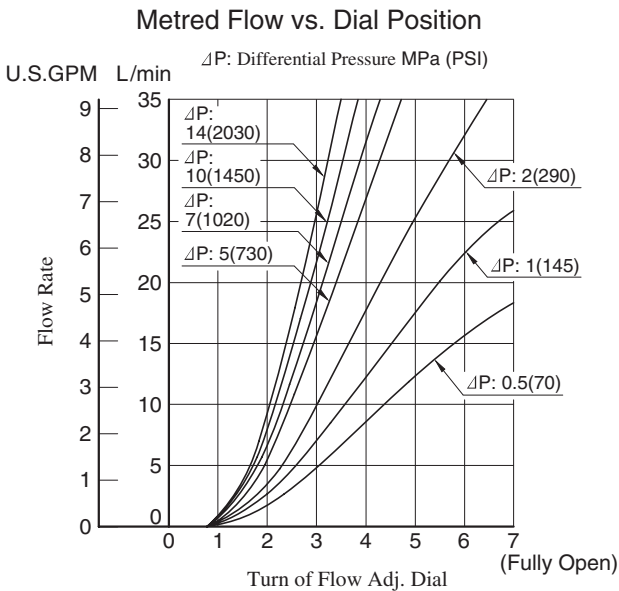
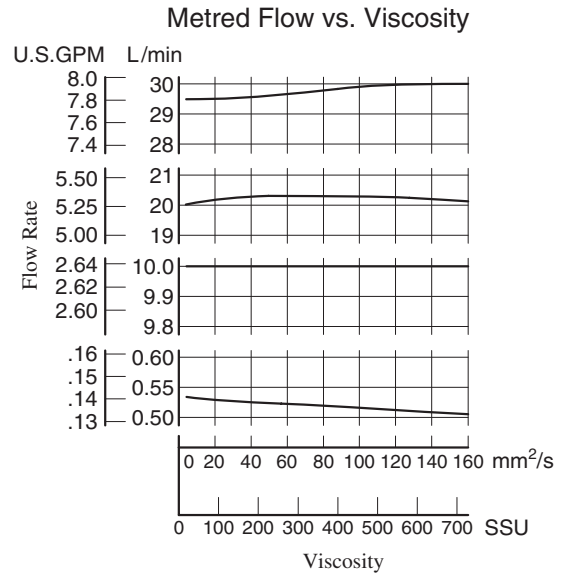
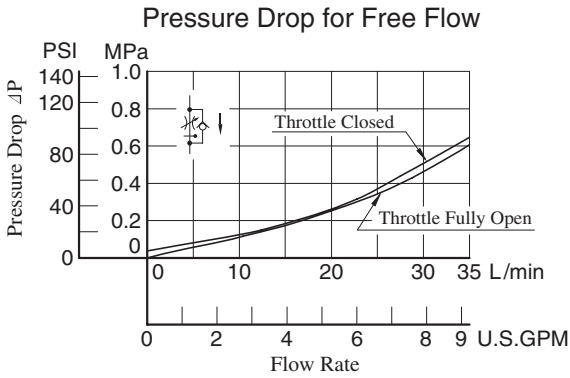
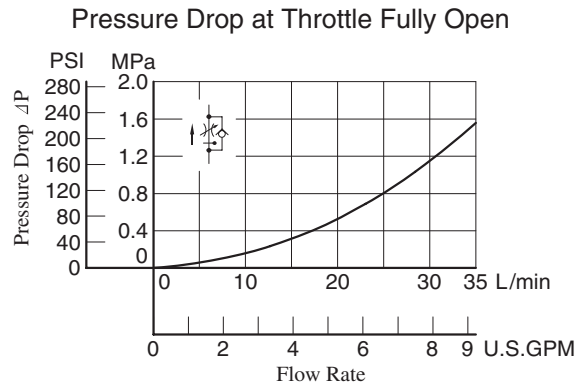
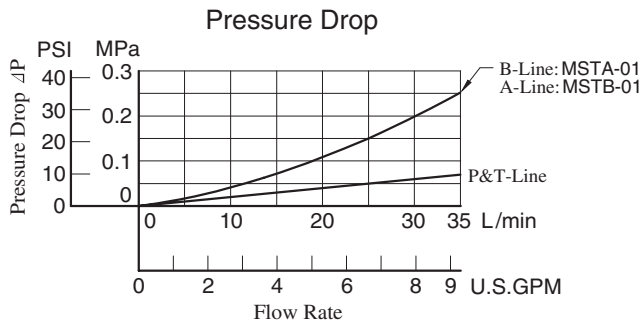

MSTW-01-X-10

DIMENSIONS IN MILLIMETRES (INCHES)

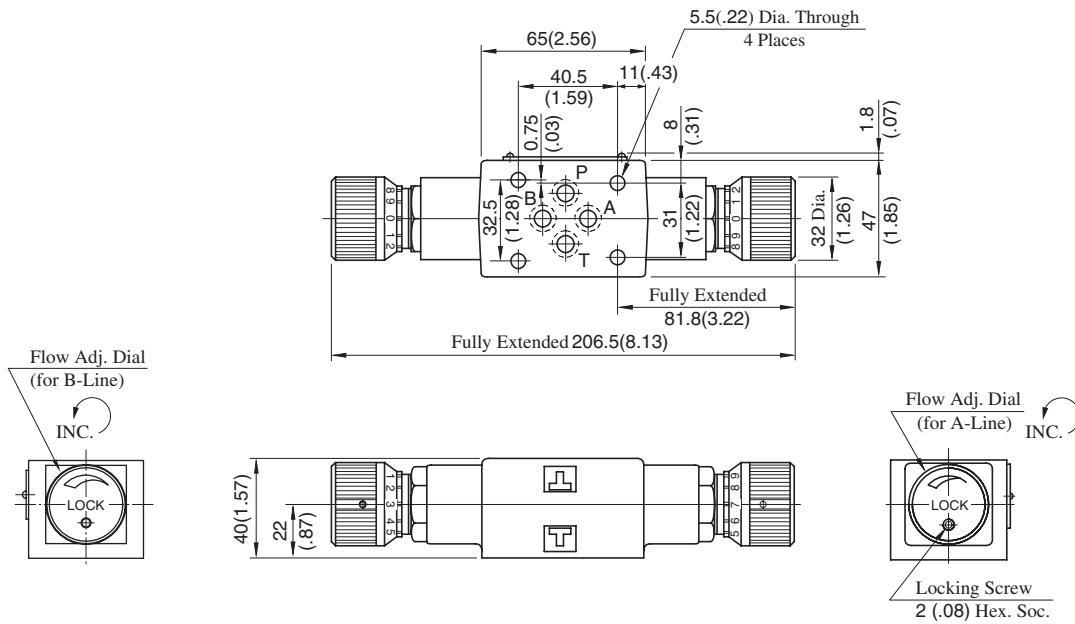

Approx. Mass..... 1.5 kg (3.3 lbs.)

MSTA-01-X-10

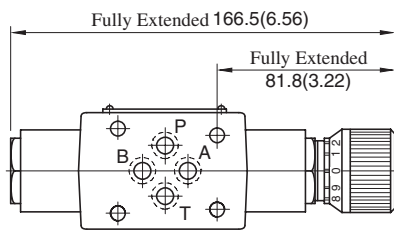

Approx. Mass..... 1.3 kg (2.9 lbs.)

MSTB-01-X-10

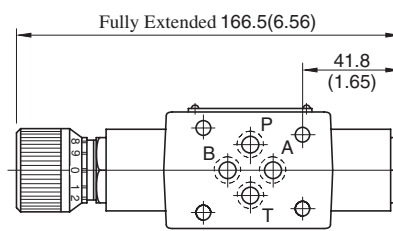

Approx. Mass..... 1.3 kg (2.9 lbs.)

• For other dimensions, refer to "MSTW-01" drawing above.



■ Spare Parts List

MSTA-01-X-10

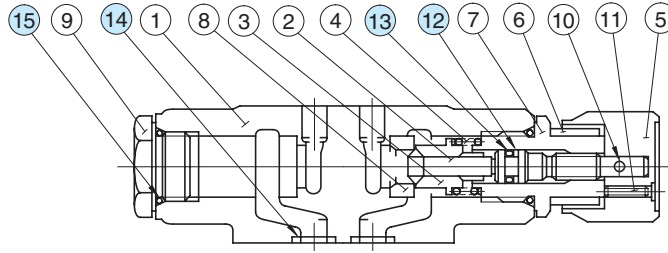

MSTB-01-X-10

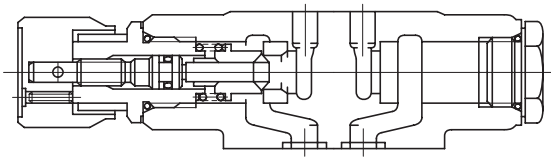

MSTW-01-X-10

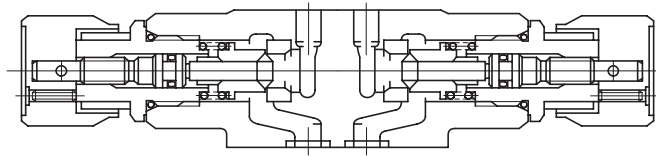

● List of Seals

Item	Name of Parts	Part Numbers	Quantity		
			MSTA	MSTB	MSTW
12	Back Up Ring	SO-BB-P6	1	1	2
13	O-Ring	SO-NA-P6	1	1	2
14	O-Ring	SO-NB-P9	4	4	4
15	O-Ring	SO-NB-P18	2	2	2

● List of Seal Kits

Valve Model Numbers	Seal Kit Numbers
MSTA-01	KS-MFA-01-10
MSTB-01	
MSTW-01	KS-MFW-01-10

Note: When ordering seals, please specify the seal kit number from the table right.

Throttle Modular Valves

Specifications

Model Number	Max. Operating Pressure MPa (PSI)	Max. Flow L/min (U.S.GPM)
MSP-01-50	31.5 (4570)	60 (15.9)★

★ At the low differential pressure, maximum flow is limited. See "Pressure Drop at Throttle Fully Open".

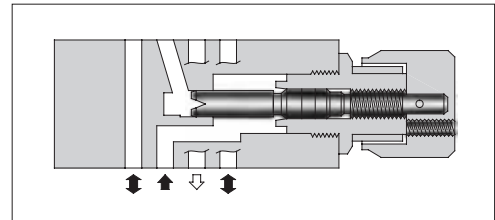

Model Number Designation

F-	MSP	-01	-50	*
Special Seals	Series Number	Valve Size	Design Number	Design Standard
F: Special Seals for Phosphate Ester Type Fluids (Omit if not required)	MSP: Throttle Valve for P-Line	01	50	Refer to ★

★ Design Standards: None Japanese Standard "JIS", European Design Standard and N. American Design Standard

Graphic Symbol



F

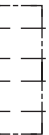

01 Series Modular Valves

Typical Performance Characteristics

Hydraulic Fluid: Viscosity 35 mm²/s (164 SSU), Specific Gravity 0.850

Pressure Drop at Throttle Fully Open

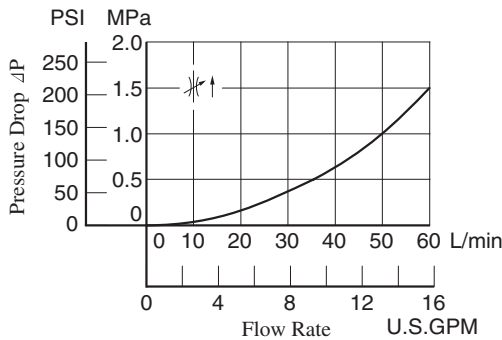

Pressure Drop

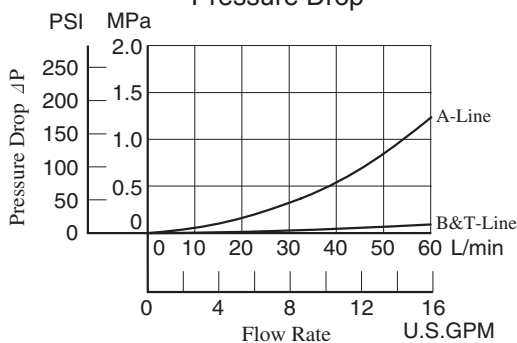

Metred Flow vs. Dial Position

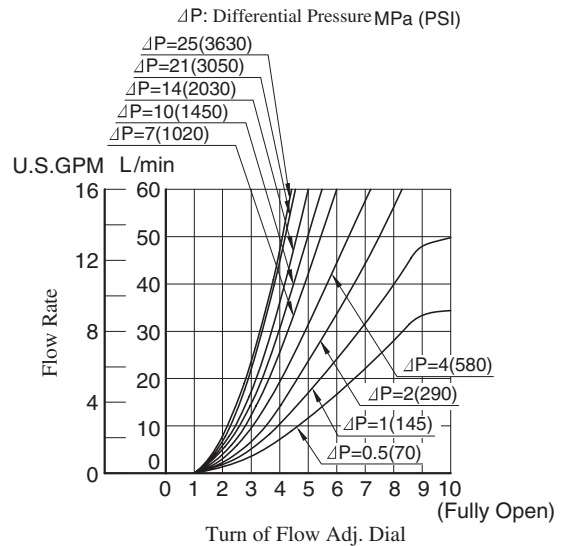

Instructions

- To make flow rate adjustment, loosen locking screw for the dial and turn the flow adjustment dial clockwise or anti-clockwise. For a decrease of flow, turn the dial clockwise. Be sure to re-tighten the locking screw firmly after the adjustment of the flow rate.

MSP-01-50

DIMENSIONS IN MILLIMETRES (INCHES)

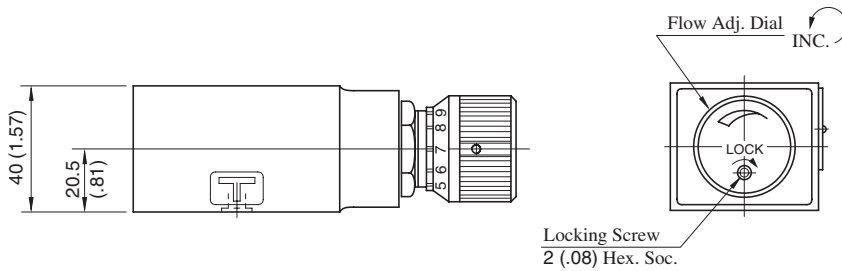
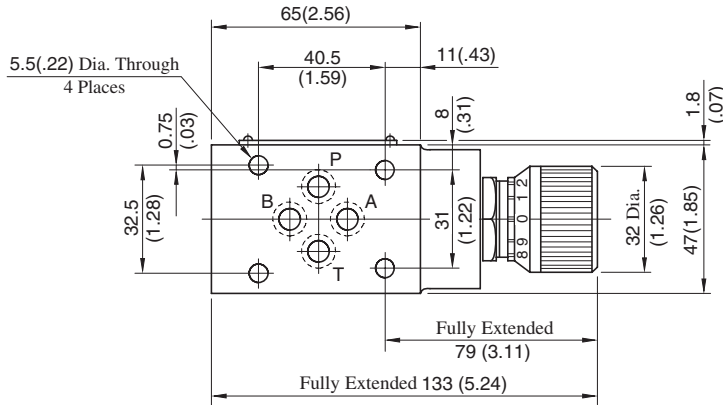

Approx. Mass..... 1.2 kg (2.6 lbs.)

■ Spare Parts List

MSP-01-50

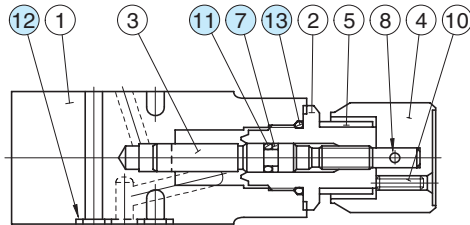

● List of Seals

Item	Name of Parts	Part Numbers	Qty.	Remarks
7	Back Up Ring	SO-BB-P6	1	Included in Seal Kit Kit No.: KS-MSP-01-50
11	O-Ring	SO-NA-P6	1	
12	O-Ring	SO-NB-P9	4	
13	O-Ring	SO-NB-P18	1	

Check and Throttle Modular Valves

Specifications

Model Number	Max. Operating Pressure MPa (PSI)	Max. Flow L/min (U.S.GPM)
MSCP-01-30	31.5 (4570)	35 (9.25)★

★ At the low differential pressure, maximum flow is limited. See "Pressure Drop at Throttle Fully Open".

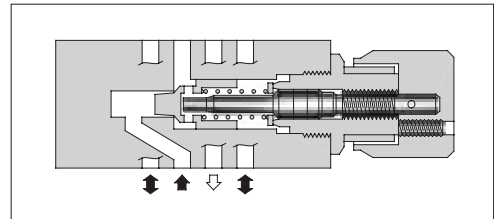

Model Number Designation

F-	MSCP	-01	-30	*
Special Seals	Series Number	Valve Size	Design Number	Design Standard
F: Special Seals for Phosphate Ester Type Fluids (Omit if not required)	MSCP : Check and Throttle Valve for P-Line	01	30	Refer to ★

★ Design Standards: None Japanese Standard "JIS", European Design Standard and N. American Design Standard

Graphic Symbol

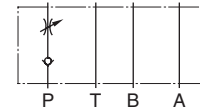

Typical Performance Characteristics

Hydraulic Fluid: Viscosity 35 mm²/s (164 SSU), Specific Gravity 0.850

Pressure Drop at Throttle Fully Open

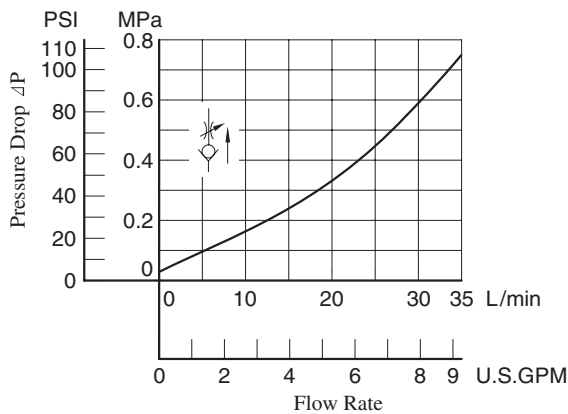

Metred Flow vs. Dial Position

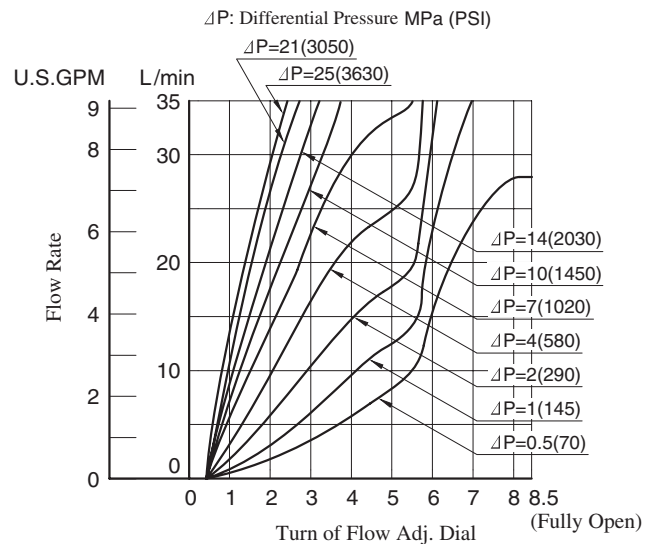

Pressure Drop

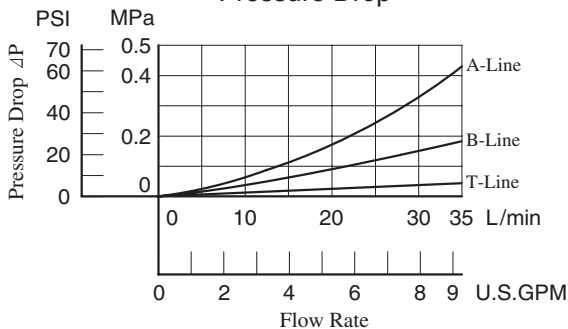

Instructions

- To make flow rate adjustment, loosen locking screw for the dial and turn the flow adjustment dial clockwise or anti-clockwise. For a decrease of flow, turn the dial clockwise. Be sure to re-tighten the locking screw firmly after the adjustment of the flow rate.

MSCP-01-30

**DIMENSIONS IN
MILLIMETRES (INCHES)**

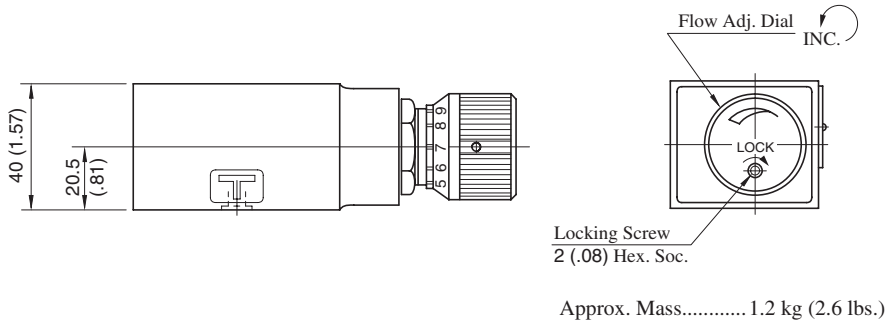
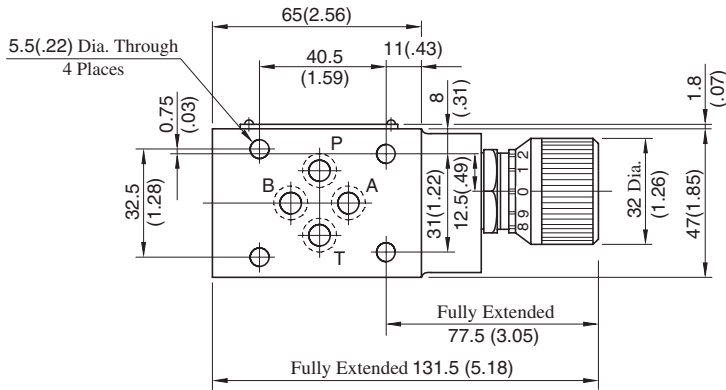

■ Spare Parts List

MSCP-01-30

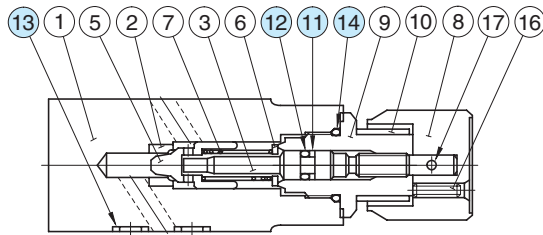

● List of Seals

Item	Name of Parts	Part Numbers	Qty.	Remarks
11	Back Up Ring	SO-BB-P6	1	Included in Seal Kit Kit No.: KS-MSP-01-30
12	O-Ring	SO-NA-P6	1	
13	O-Ring	SO-NB-P9	4	
14	O-Ring	SO-NB-P18	1	

Throttle and Check Modular Valves

Specifications

Model Numbers	Max. Operating Pressure MPa (PSI)	Max. Flow L/min (U.S.GPM)
MSA-01-**-50 MSB-01-**-50 MSW-01-**-50	31.5 (4570)	60 (15.9) *

* At the low differential pressure, maximum flow is limited. See "Pressure Drop at Throttle Fully Open" of the next page.

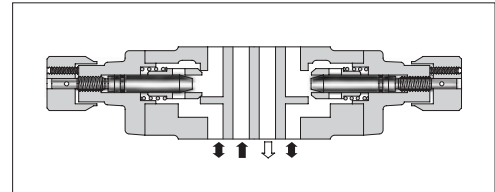

Model Number Designation

F-	MSW	-01	-X	Y	-50	*
Special Seals	Series Number	Valve Size	Direction of Flow ("A" Line)	Direction of Flow ("B" Line)	Design Number	Design Standard
F: Special Seals for Phosphate Ester Type Fluids (Omit if not required)	MSA : Throttle and Check Valve for A-Line	01	X : Metre-out Y : Metre-in	—	50	Refer to *
	MSB : Throttle and Check Valve for B-Line		—	X : Metre-out Y : Metre-in		
	MSW : Throttle and Check Valve for A&B-Lines		X : Metre-out Y : Metre-in	Y : Metre-in		
			Y : Metre-in	X : Metre-out		

* Design Standards: None Japanese Standard "JIS", European Design Standard and N. American Design Standard

Instructions

- To make flow rate adjustment, loosen locking screw for the dial and turn the flow adjustment dial clockwise or anti-clockwise. For a decrease of flow, turn the dial clockwise. Be sure to re-tighten the locking screw firmly after the adjustment of the flow rate.

Graphic Symbols

Metre-out	Metre-in
 MSA-01-X	 MSA-01-Y
 MSB-01-X	 MSB-01-Y
 MSW-01-X	 MSW-01-Y
Metre-out · Metre-in	Metre-in · Metre-out
 MSW-01-XY	 MSW-01-YX

Typical Performance Characteristics

Hydraulic Fluid: Viscosity 35 mm²/s (164 SSU), Specific Gravity 0.850

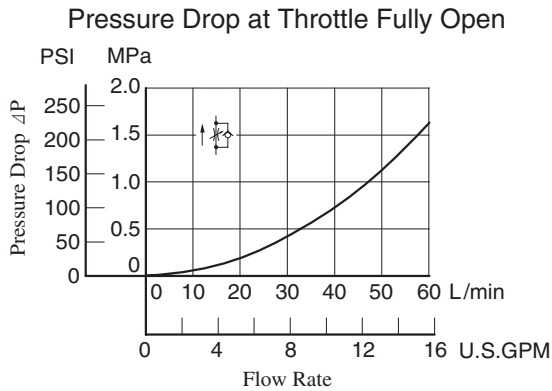
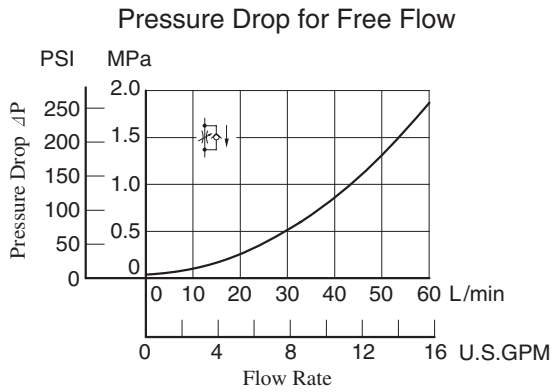
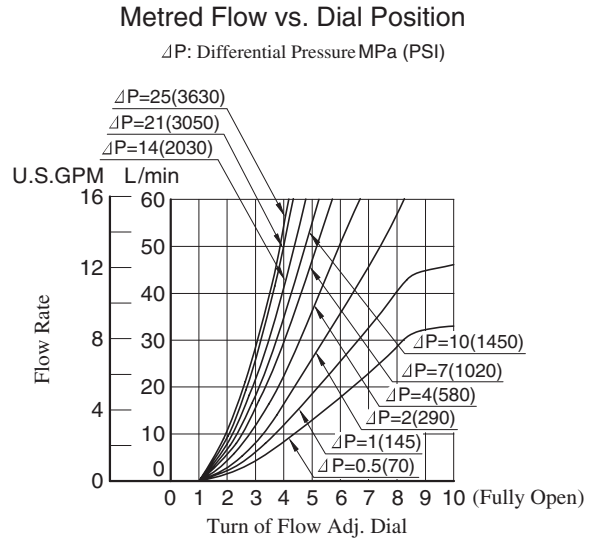
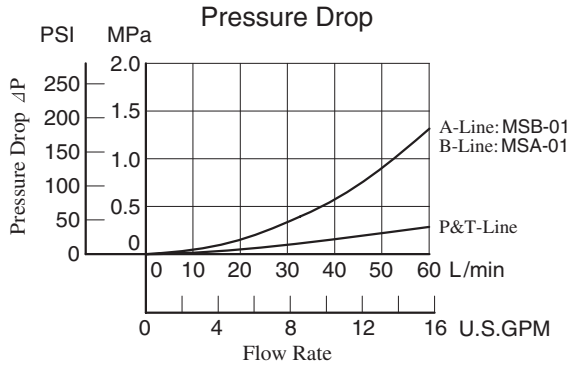

Application

Circuit of Clamp Cylinder for Injection Molding Machine

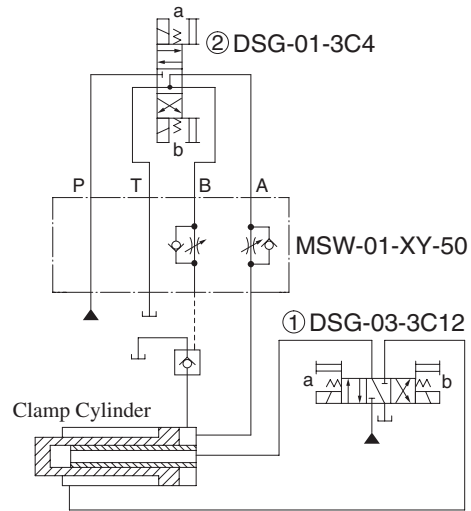

Operation Sequence

Clamp Cylinder	Advance	End Point Pressurisation	Decompression	Retreat
Solenoid Operated Directional Valve ①	Sol.a ON	→	Centre Position	Sol.b ON
Solenoid Operated Directional Valve ②	Sol.b ON	Sol.a ON	Sol.b ON	→

MSW-01-X_Y-50

DIMENSIONS IN MILLIMETRES (INCHES)

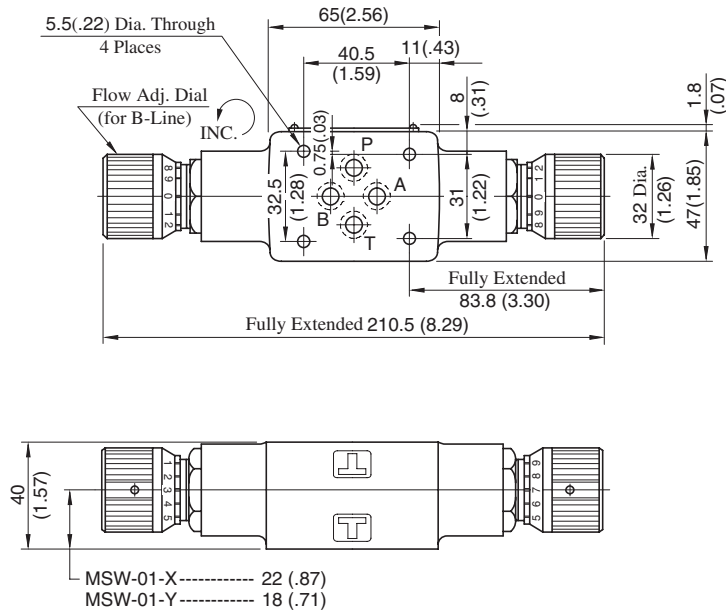

Approx. Mass..... 1.5 kg (3.3 lbs.)

MSW-01-XY_{YX}-50

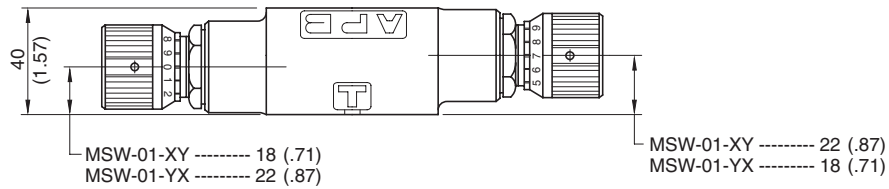

Approx. Mass..... 1.5 kg (3.3 lbs.)

• For other dimensions, refer to "MSW-01-X_Y" drawing above.

MSA-01-X_Y-50

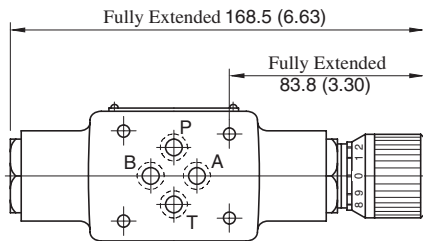

Approx. Mass..... 1.3 kg (2.9 lbs.)

MSB-01-X_Y-50

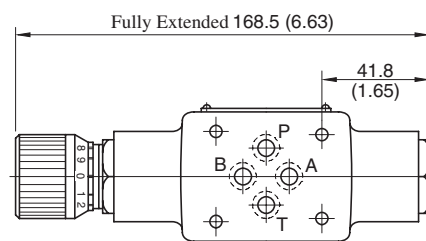

Approx. Mass..... 1.3 kg (2.9 lbs.)

• For other dimensions, refer to "MSW-01" drawing above.

■ Spare Parts List

MSA-01-X-Y-50

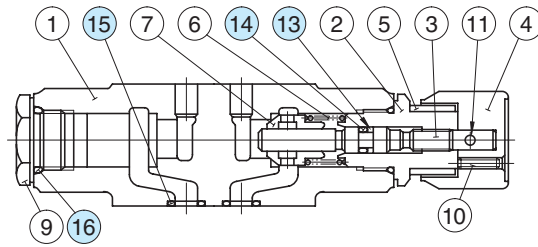

MSB-01-X-Y-50

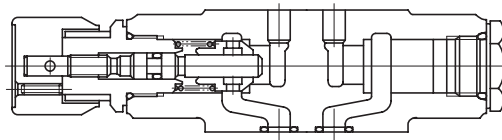

MSW-01-**-50

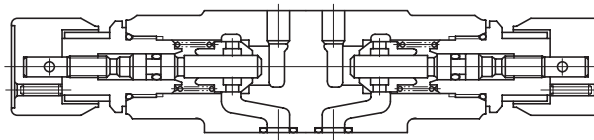

● List of Seals

Item	Name of Parts	Part Numbers	Quantity	
			MSA,MSB	MSW
13	Back Up Ring	SO-BB-P6	1	2
14	O-Ring	SO-NA-P6	1	2
15	O-Ring	SO-NB-P9	4	4
16	O-Ring	SO-NB-P18	2	2

Note: When ordering seals, please specify the seal kit number from the table right.

● List of Seal Kits

Valve Model Numbers	Seal Kit Numbers
MSA-01	KS-MSA-01-30
MSB-01	
MSW-01	KS-MSW-01-30

Check Modular Valves

Specifications

Model Numbers	Max. Operating Pressure MPa (PSI)	Max. Flow L/min (U.S.GPM)
MCP-01-*-30 MCT-01-*-30	31.5 (4570)	35 (9.25)

Model Number Designation

F-	MCP	-01	-0	-30	*
Special Seals	Series Number	Valve Size	Cracking Pressure MPa (PSI)	Design Number	Design Standard
F: Special Seals for Phosphate Ester Type Fluids (Omit if not required)	MCP: Check Valve for P-Line MCT: Check Valve for T-Line	01	0: 0.035 (5) 2: 0.2 (29) 4: 0.4 (58)	30	Refer to ★

★ Design Standards: None Japanese Standard "JIS", European Design Standard and N. American Design Standard

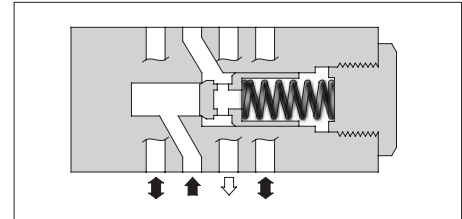

Graphic Symbols

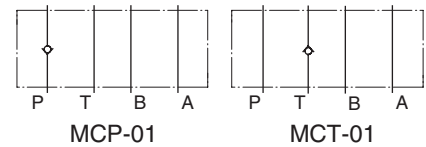

Typical Performance Characteristics

Hydraulic Fluid: Viscosity 35 mm²/s (164 SSU),
Specific Gravity 0.850

Pressure Drop for Free Flow

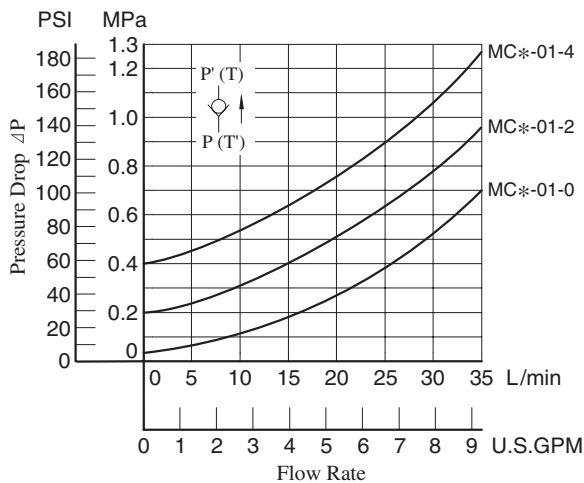

Pressure Drop

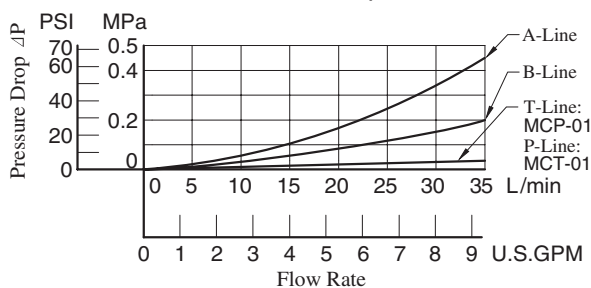

MCP
MCT-01-*-30

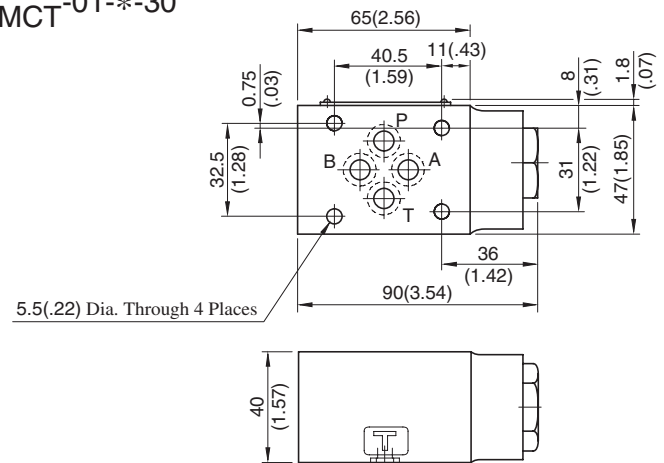

DIMENSIONS IN MILLIMETRES (INCHES)

Approx. Mass..... 1.1 kg (2.4 lbs.)

MCP
MCT-01-*-30

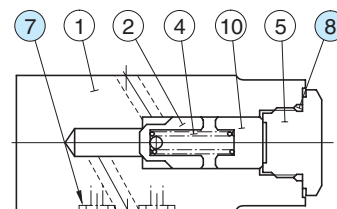

List of Seals

Item	Name of Parts	Part Numbers	Qty.	Remarks
7	O-Ring	SO-NB-P9	4	Included in Seal Kit
8	O-Ring	SO-NB-P18	1	Kit No.: KS-MCP-01-30

Anti-Cavitation Modular Valves

Specifications

Model Number	Max. Operating Pressure MPa (PSI)	Max. Flow L/min (U.S.GPM)
MAC-01-30	31.5 (4570)	35 (9.25)

Model Number Designation

F-	MAC	-01	-30	*
Special Seals	Series Number	Valve Size	Design Number	Design Standard
F: Special Seals for Phosphate Ester Type Fluids (Omit if not required)	MAC: Anti-Cavitation Valve	01	30	Refer to ★

★ Design Standards: None Japanese Standard "JIS", European Design Standard and N. American Design Standard

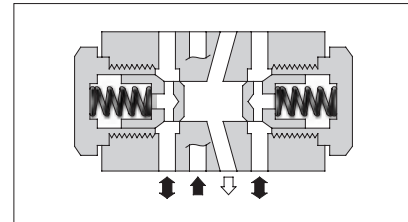

Graphic Symbol

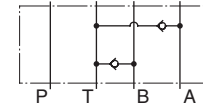

Pressure Drop

Hydraulic Fluid: Viscosity 35 mm²/s (164 SSU),
Specific Gravity 0.850

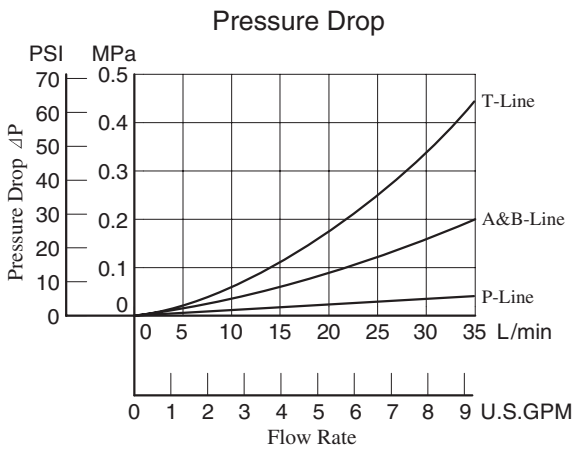

MAC-01-30

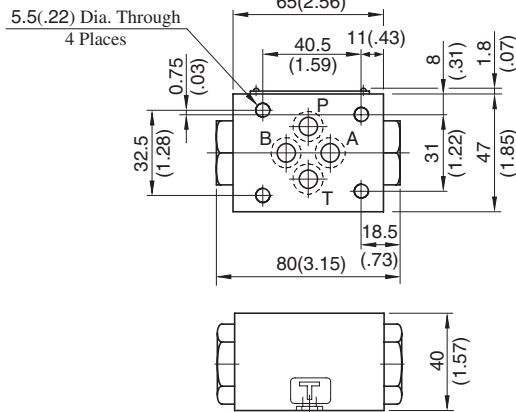

DIMENSIONS IN MILLIMETRES (INCHES)

Approx. Mass.....0.8 kg (1.8 lbs.)

MAC-01-30

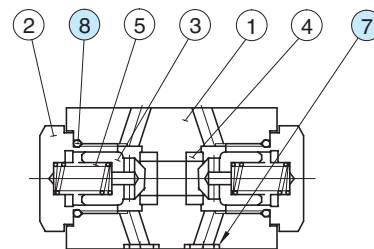

List of Seals

Item	Name of Parts	Part Numbers	Qty.	Remarks
7	O-Ring	SO-NB-P9	4	Included in Seal Kit
8	O-Ring	SO-NB-P18	2	Kit No.: KS-MAC-01-30

Pilot Operated Check Modular Valves

Specifications

Model Numbers		Max. Operating Pressure MPa (PSI)	Max. Flow L/min (U.S.GPM)
Standard	MP*-01-*-40	31.5 (4570)	35 (9.25)
Low Pilot Pressure Control Type	MP*-01-*-4001		

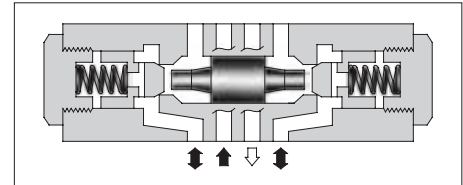

Model Number Designation

F-	MPA	-01	-2	-40	*
Special Seals	Series Number	Valve Size	Cracking Pressure MPa (PSI)	Design Number	Design Standard
F: Special Seals for Phosphate Ester Type Fluids (Omit if not required)	MPA : Pilot Operated Check Valve for A-Line MPB : Pilot Operated Check Valve for B-Line MPW : Pilot Operated Check Valve for A&B-Lines	01	2 : 0.2 (29) 4 : 0.4 (58)	40 (Standard) 4001 (Low Pilot Pressure Control Type)	Refer to ★

★ Design Standards: None Japanese Standard "JIS", European Design Standard and N. American Design Standard

Graphic Symbols

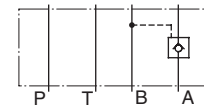

MPA-01

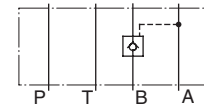

MPB-01

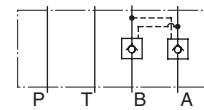

MPW-01

Typical Performance Characteristics

Hydraulic Fluid: Viscosity 35 mm²/s (164 SSU),
Specific Gravity 0.850

Pressure Drop for Free Flow

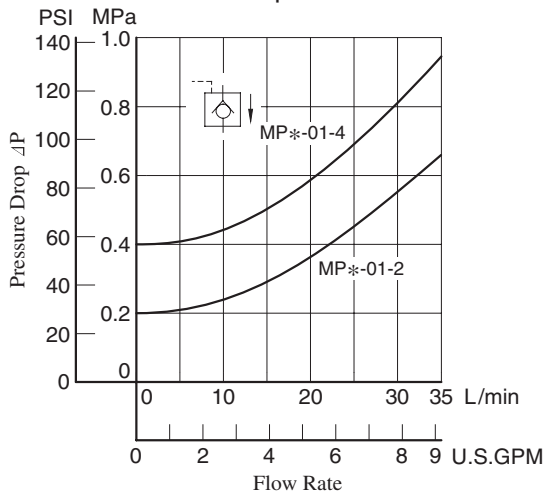

Pressure Drop for Reversed Controlled Flow

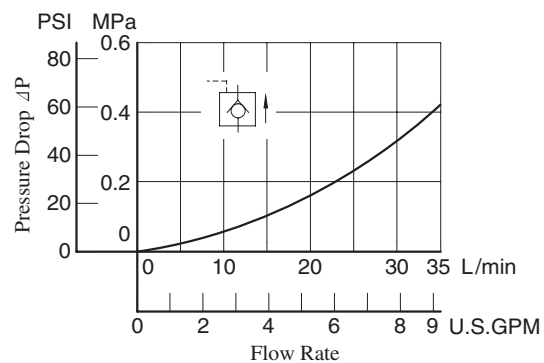

Pressure Drop

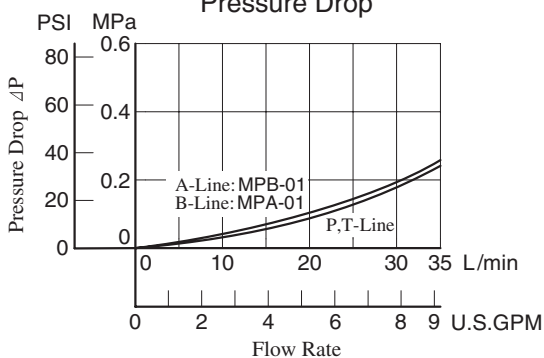

Min. Pilot Pressure

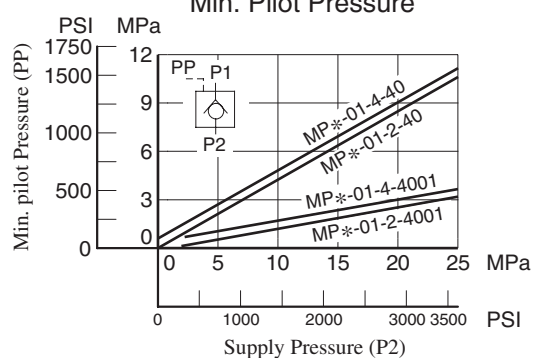

F
01 Series Modular Valves

MPA-01-*-40/4001
 MPB-01-*-40/4001
 MPW-01-*-40/4001

**DIMENSIONS IN
 MILLIMETRES (INCHES)**

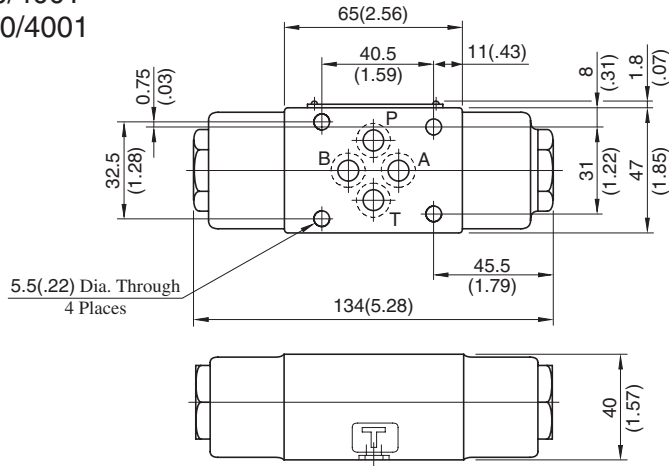

Approx. Mass..... 1.2 kg (2.6 lbs.)

■ Spare Parts List

MPW-01-*-40

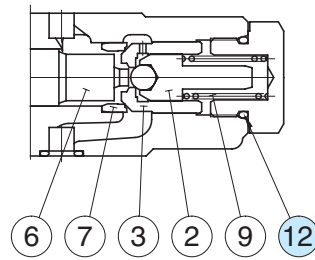
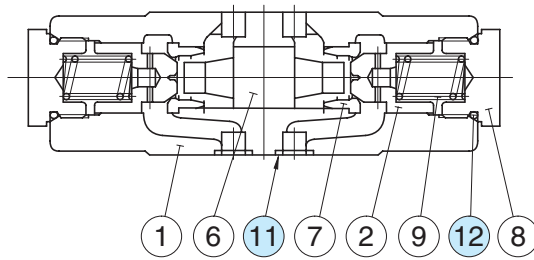

Low Pilot Pressure Control Type
 (MPW-01-*-4001)

MPA-01-*-40

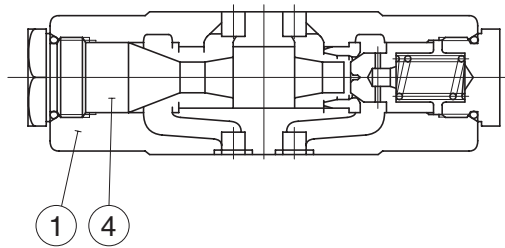

MPB-01-*-40

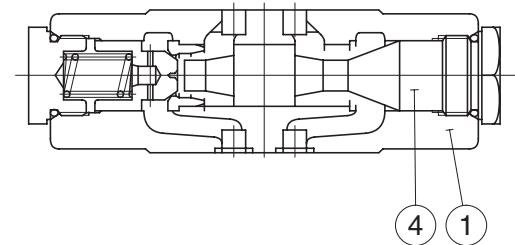

● List of Seals

Item	Name of Parts	Part Numbers	Qty.	Remarks
11	O-Ring	SO-NB-P9	4	Included in Seal Kit Kit No.: KS-MAC-01-30
12	O-Ring	SO-NB-P18	2	

End Plates

Blocking plates are used for auxiliary mounting surface or for closing unnecessary circuits.

Bypass plates are used for unidirectional circuits that require no solenoid operated directional valves.

Specifications

Model Numbers	Max. Operating Pressure MPa (PSI)	Max. Flow L/min (U.S.GPM)
MDC-01-*-30	31.5 (4570)	35 (9.25)



Graphic Symbols

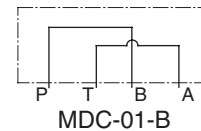
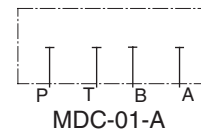

Model Number Designation

F-	MDC	-01	-A	-30	*
Special Seals	Series Number	Plate Size	Type of Plate	Design Number	Design Standard
F: Special Seals for Phosphate Ester Type Fluids (Omit if not required)	MDC: End Plate	01	A: Blocking Plate B: Bypass Plate	30	Refer to ★

★ Design Standards: None Japanese Standard "JIS", European Design Standard and N. American Design Standard

Typical Performance Characteristics

Hydraulic Fluid: Viscosity 35 mm²/s (164 SSU),
Specific Gravity 0.850

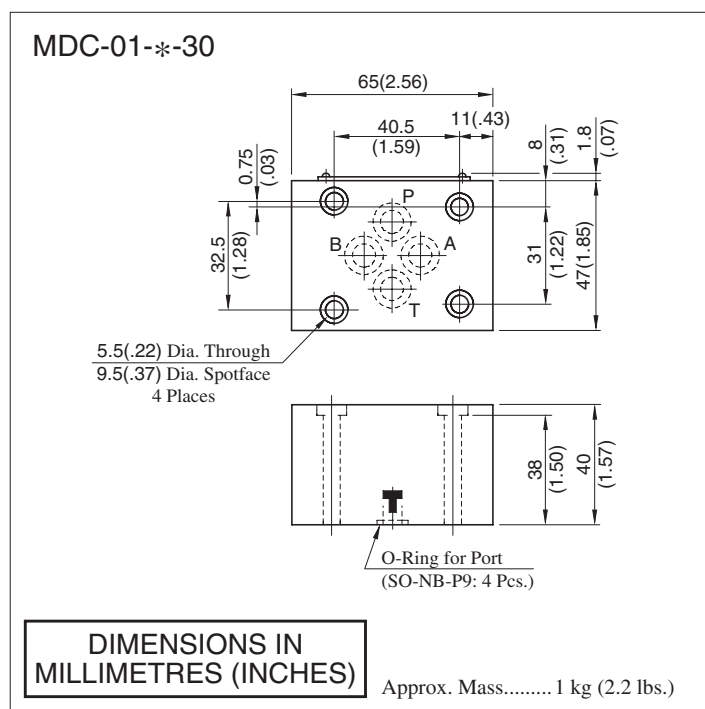
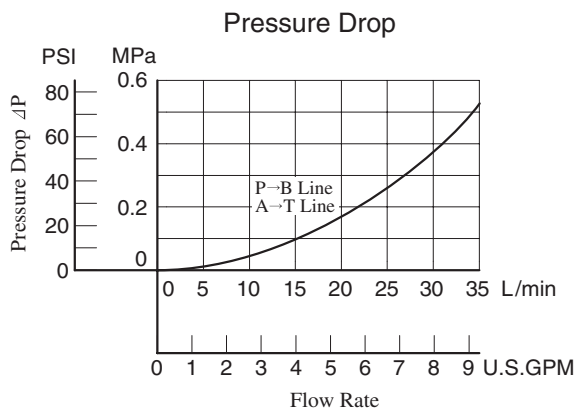

Connecting Plate

These plates are used for detecting pressure of each line.

Specifications

Model Numbers	Max. Operating Pressure MPa (PSI)	Max. Flow L/min (U.S.GPM)
MDS-01-*-30/3090	31.5 (4570)	35 (9.25)



Model Number Designation

F-	MDS	-01	-PA	-30	*
Special Seals	Series Number	Plate Size	Type of Detecting Line	Design Number	Design Standard
F : Special Seals for Phosphate Ester Type Fluids (Omit if not required)	MDS : Connecting Plate	01	PA : P&A-Lines PB : P&B-Lines AT : A&T-Lines	30	Refer to ★

★ Design Standards: None Japanese Standard "JIS" and European Design Standard
90 N. American Design Standard

Pressure Drop

Hydraulic Fluid: Viscosity 35 mm²/s (164 SSU),
Specific Gravity 0.850

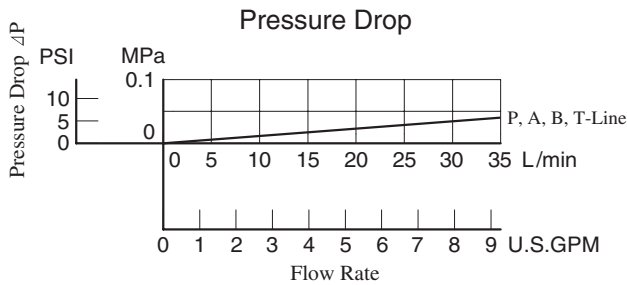

Graphic Symbols

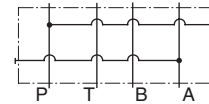

MDS-01-PA

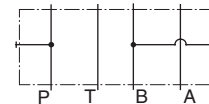

MDS-01-PB

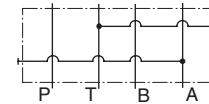

MDS-01-AT

MDS-01-*-30/3090

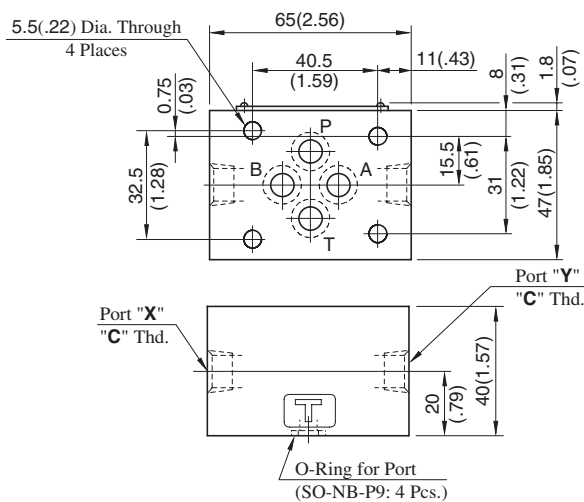

Approx. Mass.....0.8 kg (1.8 lbs.)

Model Numbers	Pressure Detecting Line	
	Port "X"	Port "Y"
MDS-01-PA	P-Line	A-Line
MDS-01-PB	B-Line	P-Line
MDS-01-AT	T-Line	A-Line

Model Numbers	Thread Size "C" Thd.
MDS-01-*-30	Rc 1/4 = 1/4 BSP.Tr
MDS-01-*-3090	1/4 NPT

**DIMENSIONS IN
MILLIMETRES (INCHES)**

Base Plates For Modular Valves

Specifications

Max. Operating Pressure ----- 25 MPa (3630 PSI)



Model Number Designation

MMC	-01	-6	-40	*
Series Number	Plate Size	Number of Stations	Design Number	Design Standard
MMC : Base Plate	01	1: 1 Station	40	None: Japanese Standard "JIS"
		2: 2 Stations		6: 6 Stations
		3: 3 Stations		90: N.American Design Standard
		4: 4 Stations		
		5: 5 Stations		
		7: 7 Stations		
		8: 8 Stations		
		9: 9 Stations		
		10: 10 Stations		

Pressure Drop

Hydraulic Fluid: Viscosity 35 mm²/s (164 SSU), Specific Gravity 0.850

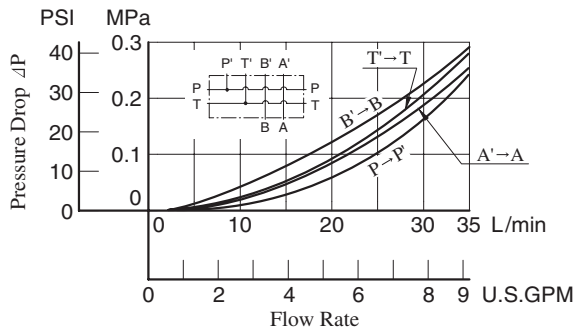

Graphic Symbols

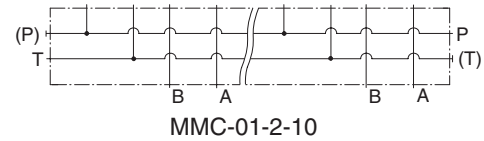
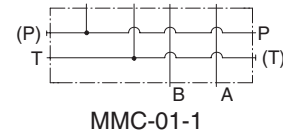

Instructions

- Port Used:** Base plate has three (two, in case of 1 station type) **pressure port "P"**s and four **tank port "T"**s. Any one of these ports or two or more ports may be used. However, please note that the ports marked with (P) or (T) in the drawing are normally plugged. Remove the plugs when using such ports. Make sure that ports that are not currently used are properly plugged.

Interface Mounting Surface Dimensions for 1/8 Modular Valve

When standard base plates (MMC-01) are not used, the mounting surface described on right must be prepared. The mounting surface should have a good machined finish.

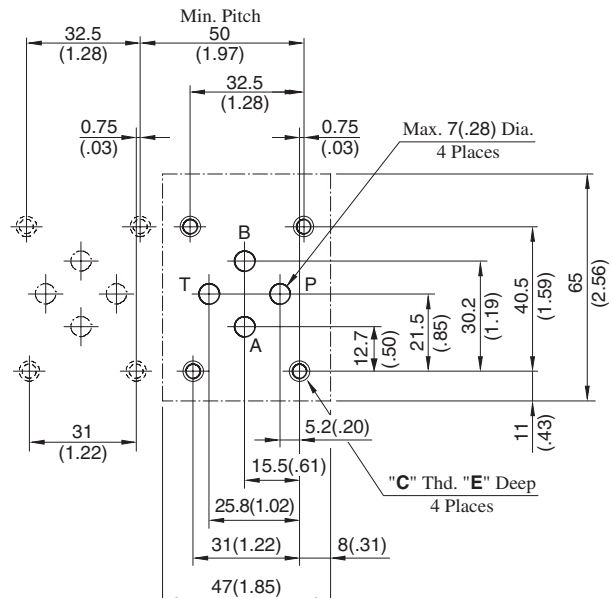

DIMENSIONS IN MILLIMETRES (INCHES)

Design Std.	"C" Thd.	E
Japanese Standard "JIS" and European Design Standard	M5	10 (.39)
N.American Design Standard	No. 10-24 UNC	12 (.47)

MMC-01-1-40/4090

DIMENSIONS IN MILLIMETRES (INCHES)

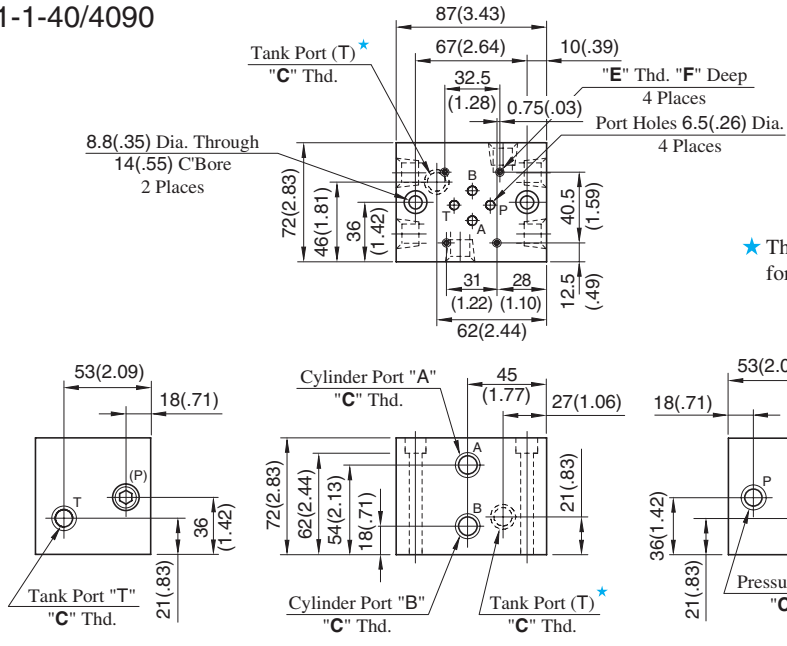

★ The two tank ports (T) are not machined for 4090 design.

Approx. Mass : 3.5 kg (7.7 lbs.)

MMC-01-*-40/4090

Number of Station (2-10 Stations)

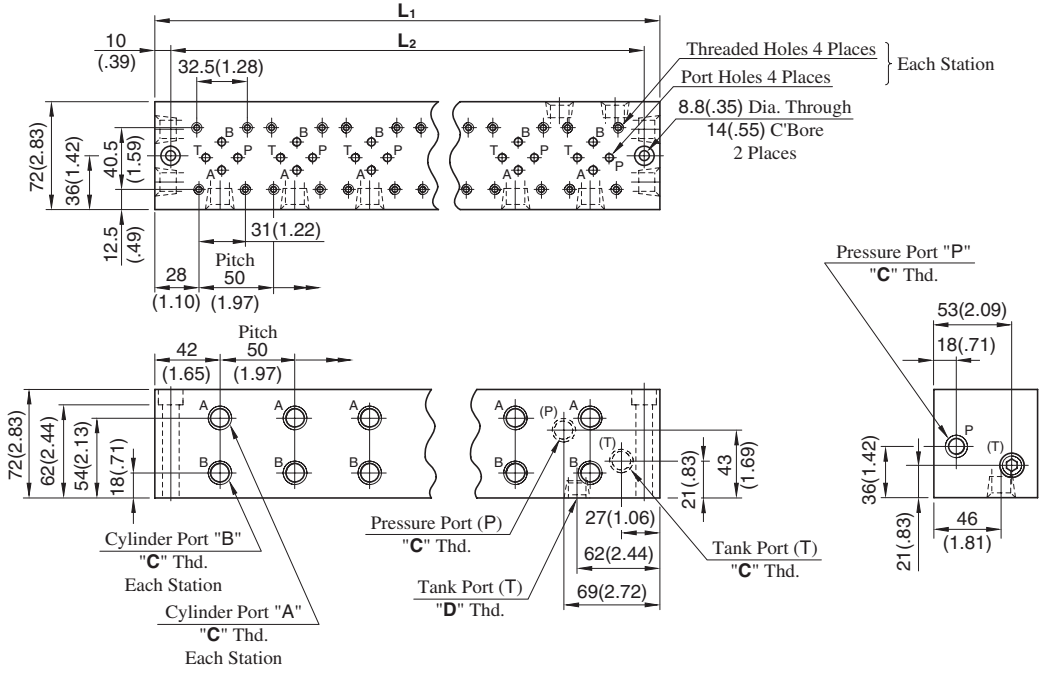

• For other dimensions, refer to above Model MMC-01-1.

Model Numbers	Thread Size			Dimensions mm (Inches)
	"C" Thd.	"D" Thd.	"E" Thd.	F
MMC-01-*-40	Rc 3/8	Rc 1/2	M5	10 (.39)
MMC-01-*-4090	3/8 NPT	1/2 NPT	No.10-24 UNC	12 (.47)

Model Numbers	Dimensions mm (Inches)		Approx. Mass kg (lbs.)	Model Numbers	Dimensions mm (Inches)		Approx. Mass kg (lbs.)
	L ₁	L ₂			L ₁	L ₂	
MMC-01-2	137 (5.39)	117 (4.61)	5.5 (12.1)	MMC-01-7	387 (15.24)	367 (14.45)	13.0 (28.7)
MMC-01-3	187 (7.36)	167 (6.57)	7.0 (15.4)	MMC-01-8	437 (17.20)	417 (16.42)	14.5 (32.0)
MMC-01-4	237 (9.33)	217 (8.54)	8.5 (18.7)	MMC-01-9	487 (19.17)	467 (18.39)	16.0 (35.3)
MMC-01-5	287 (11.30)	267 (10.51)	10.0 (22.1)	MMC-01-10	537 (21.14)	517 (20.35)	17.5 (38.6)
MMC-01-6	337 (13.27)	317 (12.48)	11.5 (25.4)				

MMC-01-1-4080

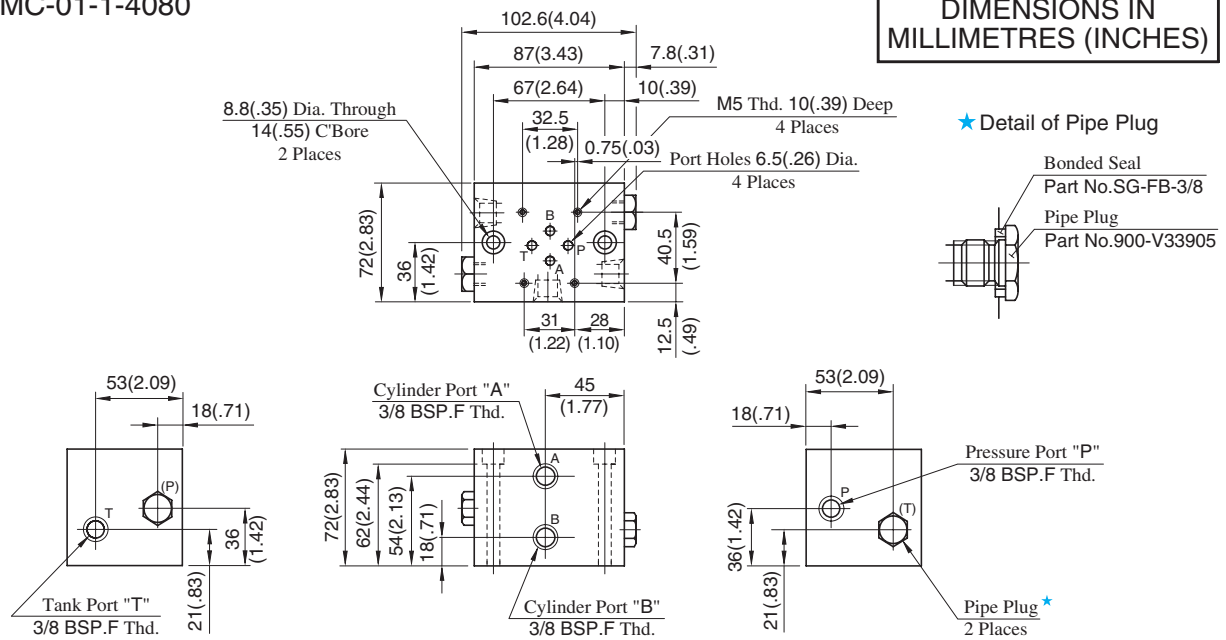

Approx. Mass : 3.5 kg (7.7 lbs.)

MMC-01-*4080

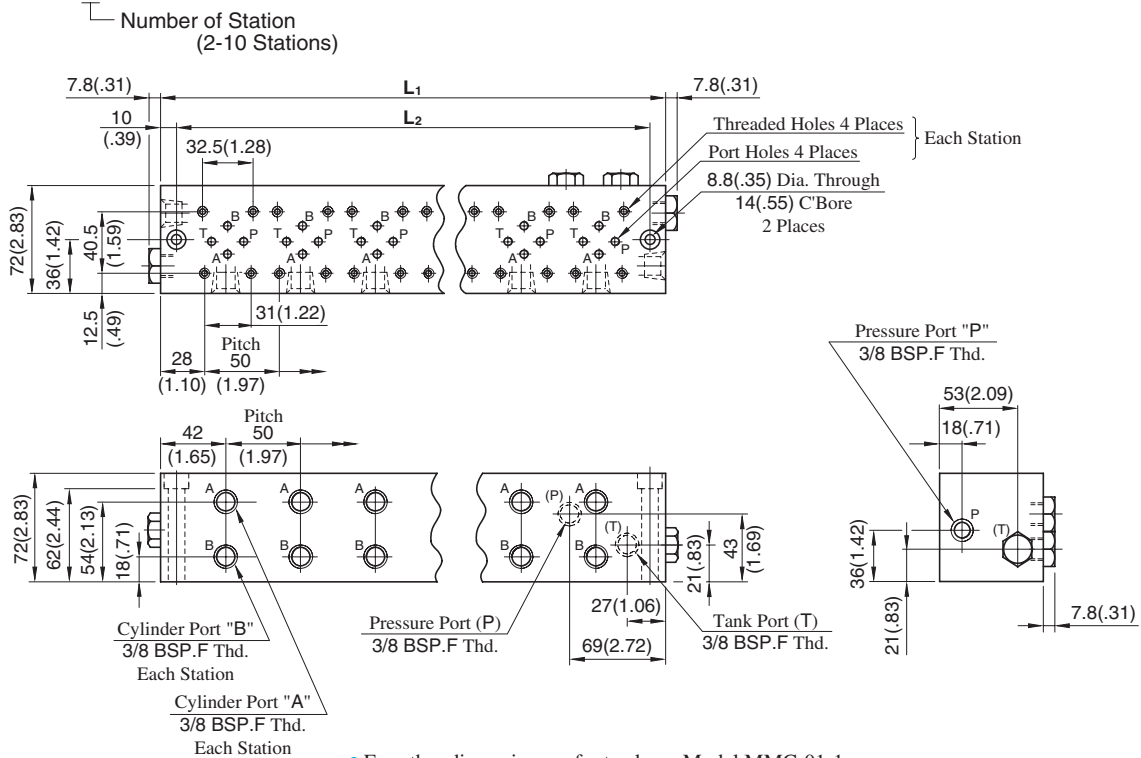

• For other dimensions, refer to above Model MMC-01-1.

Model Numbers	Dimensions mm (Inches)		Approx. Mass kg (lbs.)	Model Numbers	Dimensions mm (Inches)		Approx. Mass kg (lbs.)
	L ₁	L ₂			L ₁	L ₂	
MMC-01-2	137 (5.39)	117 (4.61)	5.5 (12.1)	MMC-01-7	387 (15.24)	367 (14.45)	13.0 (28.7)
MMC-01-3	187 (7.36)	167 (6.57)	7.0 (15.4)	MMC-01-8	437 (17.20)	417 (16.42)	14.5 (32.0)
MMC-01-4	237 (9.33)	217 (8.54)	8.5 (18.7)	MMC-01-9	487 (19.17)	467 (18.39)	16.0 (35.3)
MMC-01-5	287 (11.30)	267 (10.51)	10.0 (22.1)	MMC-01-10	537 (21.14)	517 (20.35)	17.5 (38.6)
MMC-01-6	337 (13.27)	317 (12.48)	11.5 (25.4)				

Mounting Bolt Kits

Valves are mounted with four stud bolts. Valve combination varies according to the circuit type. Hence, the mounting bolt kits are available on a combination type basis.

When ordering the bolt kit, be sure to give the bolt kit model number from the table below.

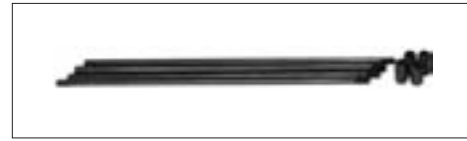

Model Number Designation

MBK	-01	-02	-30	*
Series Number	Size of Modular Valve	Bolt Number	Design Number	Design Standard
MBK: Bolt Kits for Modular Valves	01	01, 02, 03, 04, 05 (Refer to the following chart)	30	Refer to ★

★ Design Standards: None Japanese Standard "JIS" and European Design Standard 90 N. American Design Standard

Bolt Kit Composition

Stud Bolt ----- 4 Pcs. } 1 Set
Nut ----- 4 Pcs. }

Note: In case of bolt kit model number having "05", four hexagon socket head cap screws only.

Tightening Torque:

Operating Pressure MPa (PSI)	Tightening Torque Nm (in. lbs.)
25(3630) or less	5 - 6 (44 - 53)
More Than 25(3630)	6 - 7 (53 - 62)

Bolt Kits Selection Chart

Model Numbers	Quantity of valves to be stacked			Approx. Mass g (lbs.)
	Solenoid Operated Directional Valve (*-DSG-01)	End Plate (MDC-01)	Modular Valve & Connecting Plate	
MBK-01-01-30*	1	0	1	60(.13)
	0	1		
MBK-01-02-30*	1	0	2	100(.22)
	0	1		
MBK-01-03-30*	1	0	3	130(.29)
	0	1		
MBK-01-04-30* ^{★1}	1	0	4	160(.35)
	0	1		
MBK-01-05-30* ^{★2}	1	0	0	40(.09)
	0	1		

★ 1. In case of MBK-01-04-30*, operating pressure is restricted at 25 MPa (3630 PSI) or less.

★ 2. The solenoid operated directional valve comes with mounting bolts.

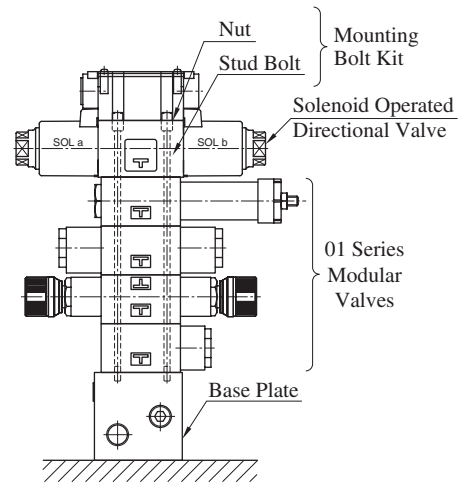

Stacking Example

MBK-01-01/02/03/04-30/3090

Stud Bolt

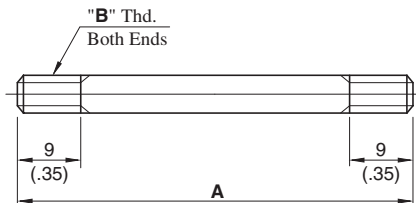

Nut

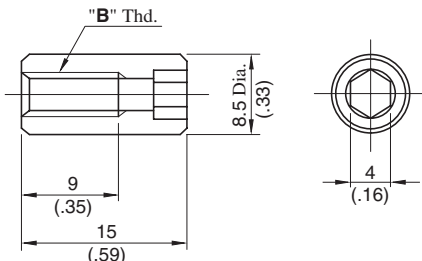

MBK-01-05-30/3090

Socket Head Cap Screw

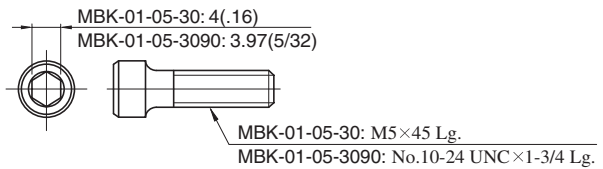

DIMENSIONS IN MILLIMETRES (INCHES)

Model Numbers	A mm (In.)	"B" Thd.
MBK-01-01-30	94 (3.70)	M5
MBK-01-02-30	134 (5.28)	
MBK-01-03-30	174 (6.85)	
MBK-01-04-30	214 (8.43)	
MBK-01-01-3090	94 (3.70)	No.10-24 UNC
MBK-01-02-3090	134 (5.28)	
MBK-01-03-3090	174 (6.85)	
MBK-01-04-3090	214 (8.43)	

3/8 Modular Valves

Type of Modular Valve

Class	Model Numbers	Graphic Symbols	Page	Class	Model Numbers	Graphic Symbols	Page	
Pressure Control Valves	Solenoid Operated Directional Valve (S-)DSG-03-***-50/5090 E-DSG-03-***-D*50/5090 T-DSG-03-***-D24*50/5090 G-DSG-03-***-50/5090		361 378 379 412	Flow Control Valves	Temperature Compensated Throttle and Check Valves (for "A&B-Lines", Metre-out) MSTW-03-X-20		595	
	Relief Valves (for "P-Line") MBP-03-*30		578		Throttle Valves (for "P-Line") MSP-03-30		598	
	Relief Valves (for "A-Line") MBA-03-*30		578		Check and Throttle Valves (for "P-Line") MSCP-03-20		600	
	Relief Valves (for "B-Line") MBB-03-*30		578		Throttle and Check Valves (for "A-Line", Metre-out) MSA-03-X-40		602	
	Relief Valves (for "A&B-Lines") MBW-03-*30		578		Throttle and Check Valves (for "A-Line", Metre-in) MSA-03-Y-40		602	
	Reducing Valves (for "P-Line") MRP-03-*30/3090		581		Throttle and Check Valves (for "B-Line", Metre-out) MSB-03-X-40		602	
	Reducing Valves (for "A-Line") MRA-03-*30/3090		581		Throttle and Check Valves (for "B-Line", Metre-in) MSB-03-Y-40		602	
	Reducing Valves (for "B-Line") MRB-03-*30/3090		581		Throttle and Check Valves (for "A&B-Lines", Metre-out) MSW-03-X-40		602	
	Reducing Valves for Low Pressure Setting (for "P-Line") MRLP-03-10/1090		584		Throttle and Check Valves (for "A&B-Lines", Metre-in) MSW-03-Y-40		602	
	Reducing Valves for Low Pressure Setting (for "A-Line") MRLA-03-10/1090		584		Directional Control Valves	Check Valves (for "P-Line") MCP-03-*10		605
	Reducing Valves for Low Pressure Setting (for "B-Line") MRLB-03-10/1090		584			Check Valves (for "A-Line") MCA-03-*20		605
	Sequence Valves (for "P-Line") MHP-03-*20		588			Check Valves (for "B-Line") MCB-03-*20		605
	Counterbalance Valves (for "A-Line") MHA-03-*20		588			Check Valves (for "T-Line") MCT-03-*10		605
	Counterbalance Valves (for "B-Line") MHB-03-*20		588			Check Valves (for "P&T-Lines") MCPT-03-P*-T*-10		607
Flow Control Valves	Flow Control Valves (for "P-Line") MFP-03-11		591	Anti-Cavitation Valves MAC-03-10			609	
	Flow Control and Check Valves (for "A-Line", Metre-out) MFA-03-X-11		591	Pilot Operated Check Valves (for "A-Line") MPA-03-*20/2001			610	
	Flow Control and Check Valves (for "A-Line", Metre-in) MFA-03-Y-11		591	Pilot Operated Check Valves (for "B-Line") MPB-03-*20/2001			610	
	Flow Control and Check Valves (for "B-Line", Metre-out) MFB-03-X-11		591	Pilot Operated Check Valves (for "A&B-Lines") MPW-03-*20/2001			610	
	Flow Control and Check Valves (for "B-Line", Metre-in) MFB-03-Y-11		591	Modular Plates and Mounting Bolts		End Plates (Blocking Plates) MDC-03-A-10		613
	Flow Control and Check Valves (for "A&B-Lines", Metre-out) MFW-03-X-11		591			End Plates (Bypass Plates) MDC-03-B-10		613
	Flow Control and Check Valves (for "A&B-Lines", Metre-in) MFW-03-Y-11		591			Connecting Plates MDS-03-10/1090		614
	Temperature Compensated Throttle and Check Valves (for "A-Line", Metre-out) MSTA-03-X-20		595			Base Plates MMC-03-T*-21/2180/2190		615
	Temperature Compensated Throttle and Check Valves (for "B-Line", Metre-out) MSTB-03-X-20		595			Bolt Kits MBK-03-*10/1090		618

Relief Modular Valves

Specifications

Model Numbers	Max. Operating Pressure MPa (PSI)	Max. Flow L/min (U.S.GPM)
MBP-03-* MBA-03-* MBB-03-* MBW-03-*	31.5 (4570)	70 (18.5)

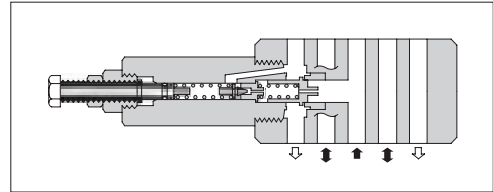

Model Number Designation

F-	MBA	-03	-B	-30	*
Special Seals	Series Number	Valve Size	Pres. Adj. Range MPa (PSI)	Design Number	Design Standard
F: Special Seals for Phosphate Ester Type Fluids (Omit if not required)	MBP : Relief Valve for P-Line MBA : Relief Valve for A-Line MBB : Relief Valve for B-Line MBW : Relief Valve for A&B-Lines	03	B : *-7 ^{★1} (*:1020) H : 3.5-31.5 (510-4570)	30	Refer to ^{★2}

★1. See the "Minimum Adjustment Pressure" of the next page for the item marked *.

★2. Design Standards: None Japanese Standard "JIS", European Design Standard and N. American Design Standard

Instructions

- The minimum adjustment pressure equals the value obtained from the minimum adjustment pressure characteristics plus the tank line back pressure of the [next page](#). This back pressure should include the value of the T-line pressure drop characteristics of the valves stacked to the base plate side of the modular valve.
- To make pressure adjustment, loosen the lock nut and turn the pressure adjustment screw clockwise or anti-clockwise. For an increase of pressure, turn the screw clockwise. Be sure to re-tighten the lock nut firmly after making adjustment to the pressure.
- In case of a small flow, the setting pressure may become unstable. To avoid this, refer to the minimum flow characteristic curve of the next page and use the valve within a range as shown with .

Model Numbers	Graphic Symbols	Detailed Graphic Symbols
MBP-03		
MBA-03		
MBB-03		
MBW-03		

Typical Performance Characteristics

Hydraulic Fluid: Viscosity 35 mm²/s (164 SSU), Specific Gravity 0.850

Nominal Override Characteristics

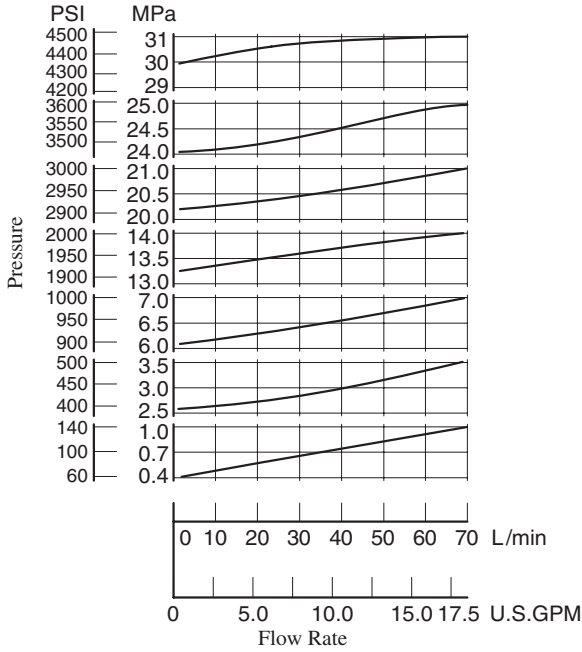

Min. Adjustment Pressure

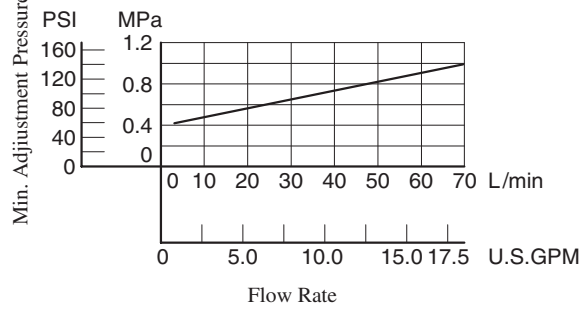

Min. Flow vs. Adjustment Pressure

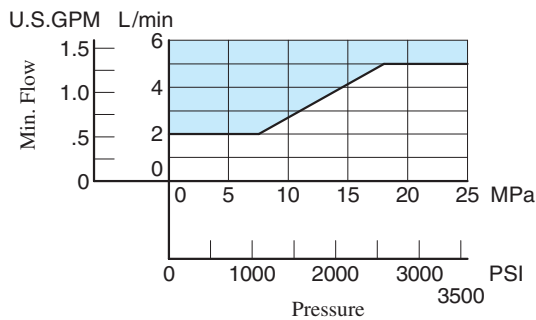

Pressure Drop

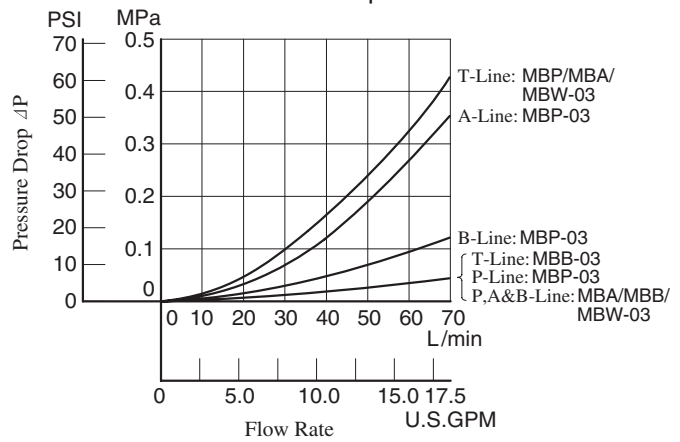

MBW-03-*-30

DIMENSIONS IN MILLIMETRES (INCHES)

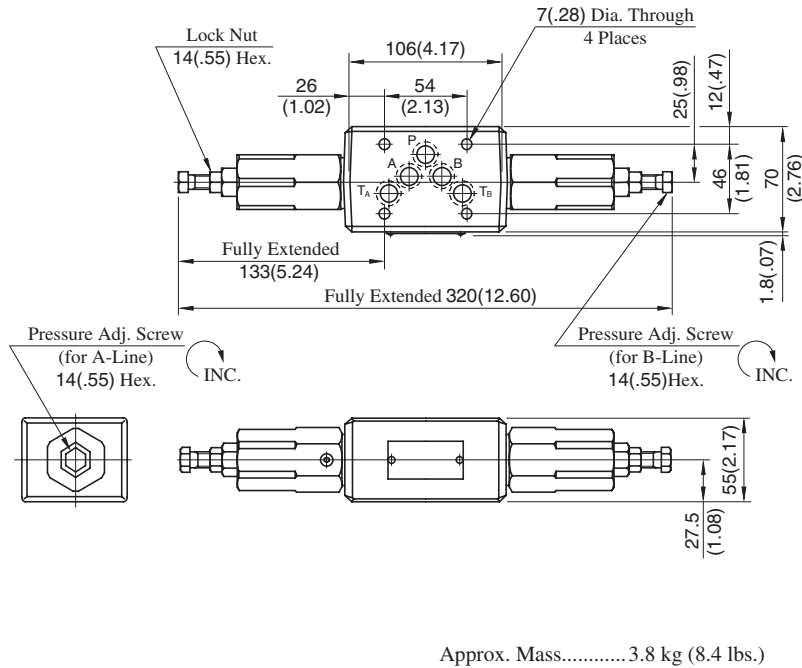

Approx. Mass..... 3.8 kg (8.4 lbs.)

**MBP-03-*-30
MBA-03-*-30**

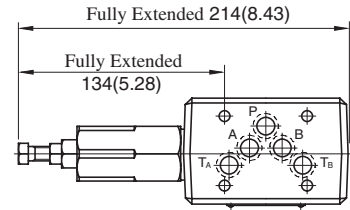

Approx. Mass..... 3.1 kg (6.8 lbs.)

• For other dimensions, refer to "MBW-03" drawing left.

MBB-03-*-30

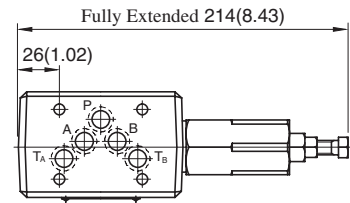

Approx. Mass..... 3.1 kg (6.8 lbs.)

• For other dimensions, refer to "MBW-03" drawing left.

■ Spare Parts List

**MBP-03-*-30
MBA-03-*-30**

MBB-03-*-30

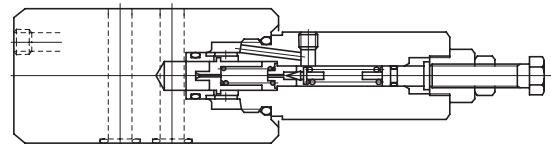
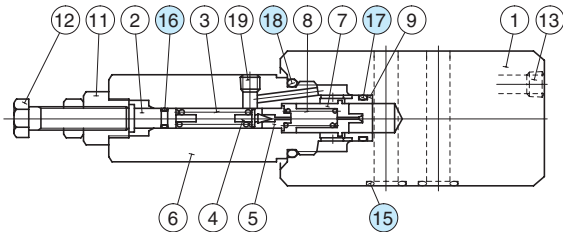

MBW-03-*-30

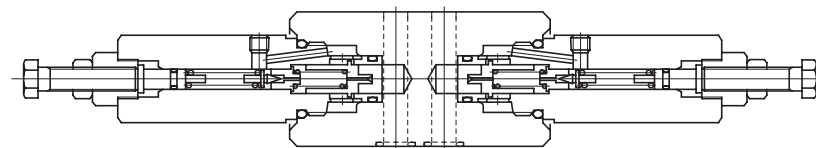

● List of Seals

Item	Name of Parts	Part Numbers	Quantity			
			MBP-03	MBA-03	MBB-03	MBW-03
15	O-Ring	SO-NB-A014	5	5	5	5
16	O-Ring	SO-NA-P6	1	1	1	2
17	O-Ring	SO-NB-P16	1	1	1	2
18	O-Ring	SO-NB-P26	1	1	1	2

Note: When ordering seals, please specify the seal kit number from the table right.

● List of Seal Kits

Valve Model Numbers	Seal kit Numbers
MBP-03	KS-MBP-03-30
MBA-03	
MBB-03	
MBW-03	KS-MBW-03-30

Reducing Modular Valves

Specifications

Model Numbers	Max. Operating Pressure MPa(PSI)	Max. Flow L/min (U.S.GPM)
MRP-03-*-30/3090 MRA-03-*-30/3090 MRB-03-*-30/3090	25 (3630)	70 (18.5) *

★ In pressure adjustment range "H", if the pressure in the primary side is set above 20 MPa (2900 PSI) and the pressure in the secondary side is set below 10 MPa (1450 PSI), the maximum flow is limited to 50 L/min (13.2 U.S.GPM).

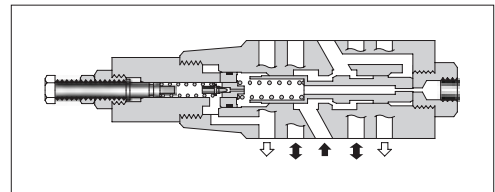

Model Number Designation

F-	MRP	-03	-B	-30	*
Special Seals	Series Number	Valve Size	Pres. Adj. Range MPa (PSI)	Design Number	Design Standard
F: Special Seals for Phosphate Ester Type Fluids (Omit if not required)	MRP: Reducing Valve for P-Line MRA: Reducing Valve for A-Line MRB: Reducing Valve for B-Line	03	B: 1-7 (145-1020) H: 3.5-24.5 (510-3550)	30	Refer to ★

★ Design Standards: None Japanese Standard "JIS" and European Design Standard
90 N. American Design Standard

Instructions

- The minimum adjustment pressure equals the lower limit of either pressure adjustment range (B, H) plus the tank line back pressure of the [next page](#). This back pressure should include the value of the T-line pressure drop characteristics of the valves stacked to the base plate side of the modular valve.
- To make pressure adjustment, loosen the lock nut and turn the pressure adjustment screw clockwise or anti-clockwise. For an increase of pressure, turn the screw clockwise. Be sure to re-tighten the lock nut firmly after making adjustment to the pressure.

Model Numbers	Graphic Symbols	Detailed Graphic Symbols
MRP-03		
MRA-03		
MRB-03		

Typical Performance Characteristics

Hydraulic Fluid: Viscosity 35 mm²/s (164 SSU), Specific Gravity 0.850

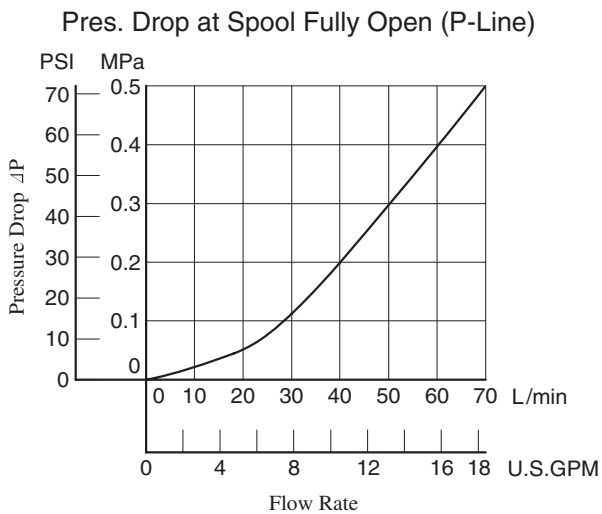
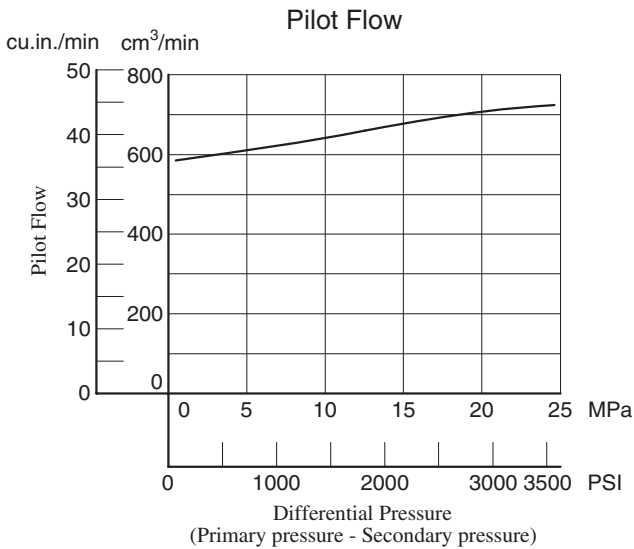
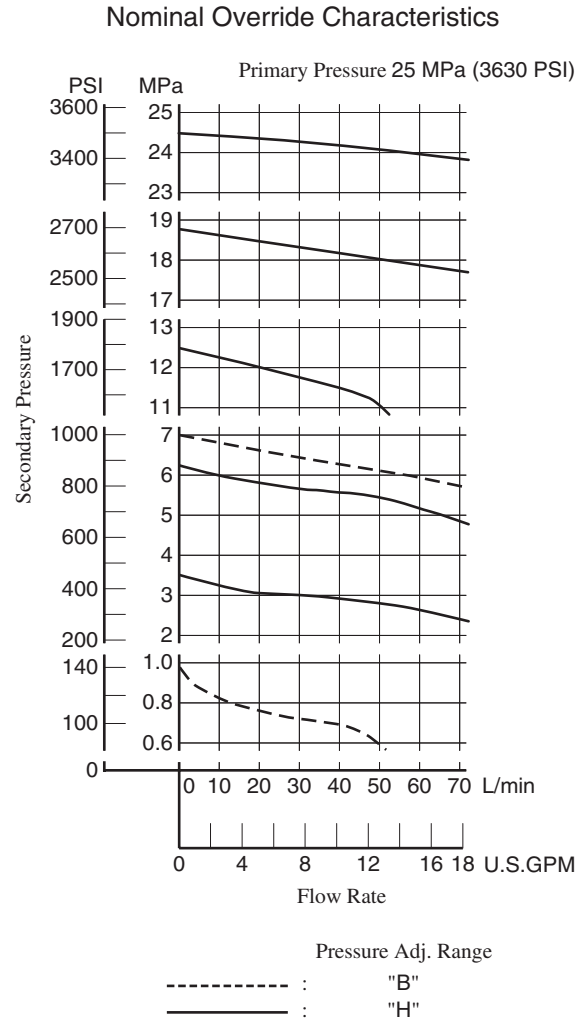
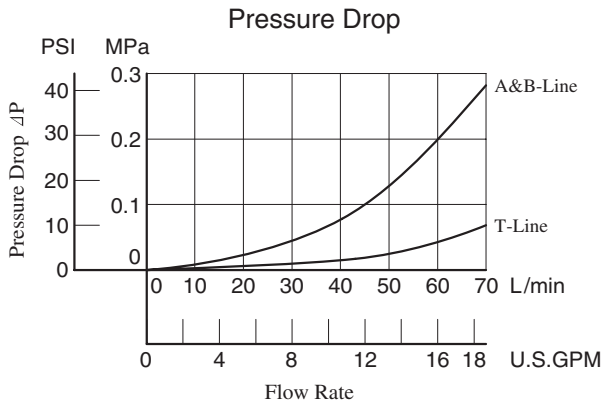

MRP-03-*-30/3090

MRB-03-*-30/3090

DIMENSIONS IN MILLIMETRES (INCHES)

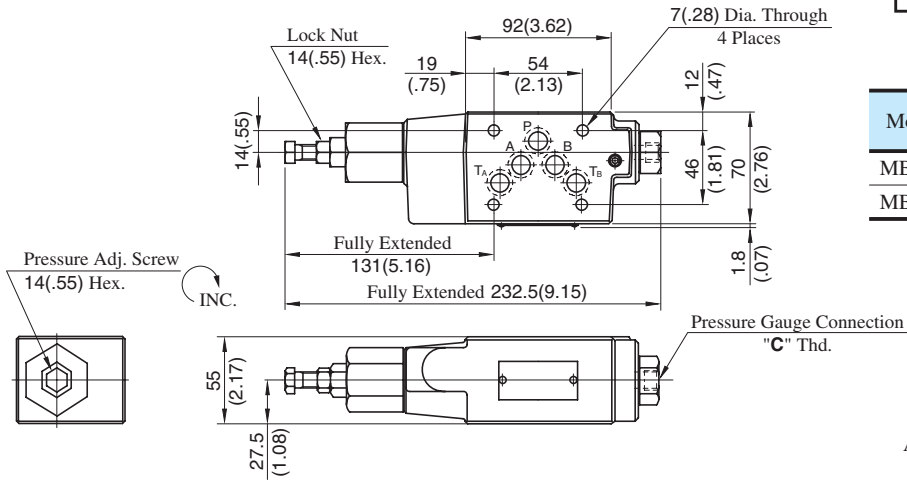

Model Numbers	Thread Size "C" Thd.
MB*-01-*-30	Rc 1/4 = 1/4 BSP.Tr
MB*-01-*-3090	1/4 NPT

Approx. Mass.....3.3 kg (7.5 lbs.)

MRA-03-*-30/3090

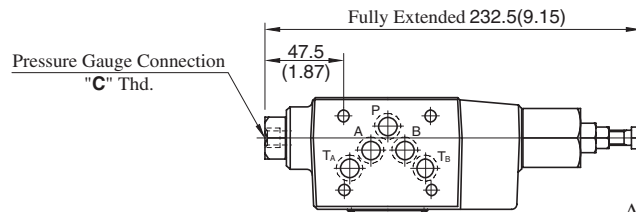

Approx. Mass.....3.3 kg (7.5 lbs.)

• For other dimensions, refer to "MRP-03" drawing above.

■ Spare Parts List

MRP-03-*-30/3090

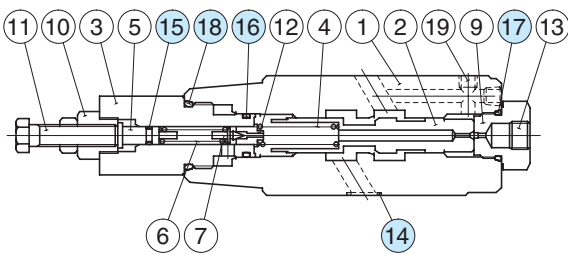

MRB-03-*-30/3090

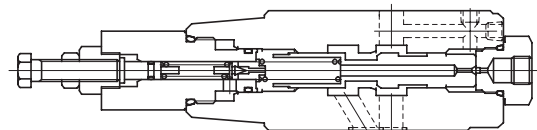

MRA-03-*-30/3090

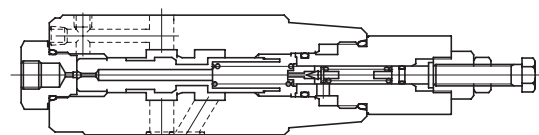

● List of Seals

Item	Name of Parts	Part Numbers	Qty.	Remarks
14	O-Ring	SO-NB-A014	5	Included in Seal Kit Kit No.: KS-MRP-03-30
15	O-Ring	SO-NA-P6	1	
16	O-Ring	SO-NB-P16	1	
17	O-Ring	SO-NB-P18	1	
18	O-Ring	SO-NB-P26	1	

■ Reducing Modular Valves For Low Pressure Setting

■ Specifications

Model Numbers	Max. Operating Pressure MPa (PSI)	Pres. Adj. Range MPa (PSI)	Max. Flow L/min (U.S.GPM)
MRLP-03-10/1080/1090 MRLA-03-10/1080/1090 MRLB-03-10/1080/1090	7 (1020)	0.2-6.5 (29-940)	50 (13.2) *

★ When pressure setting is less than 0.8 MPa (116 PSI), maximum flow decreases. See "Min. Adjustment Pressure vs. Max. Flow" on the [next page](#) for the appropriate range.

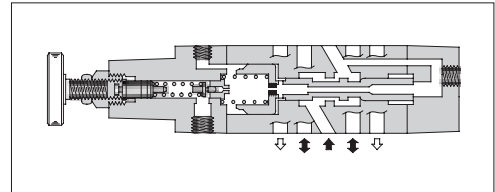

■ Model Number Designation

F-	MRLP	-03	-10	*
Special Seals	Series Number	Valve Size	Design Number	Design Standard
F: Special Seals for Phosphate Ester Type Fluids (Omit if not required)	MRLP : Low Pressure Setting Type Reducing Valve for P-Line MRLA : Low Pressure Setting Type Reducing Valve for A-Line MRLB : Low Pressure Setting Type Reducing Valve for B-Line	03	10	Refer to ★

★ Design Standards: None Japanese Standard "JIS"
80 European Design Standard
90 N. American Design Standard

■ Instructions

- If there is a pressure in drain line, it is added to the secondary setting pressure. Hence, drain line must be connected to tank directly with a low back pressure close to atmospheric pressure.
- To make pressure adjustment, loosen the lock nut and turn the pressure adjustment handle clockwise or anti-clockwise. For an increase of pressure, turn the handle clockwise. Be sure to re-tighten the lock nut firmly after making adjustment to the pressure.

Model Numbers	Graphic Symbols	Detailed Graphic Symbols
MRLP-03		
MRLA-03		
MRLB-03		

Typical Performance Characteristics

Hydraulic Fluid: Viscosity 35 mm²/s (164 SSU), Specific Gravity 0.850

Pres. Drop at Spool Fully Open (P-Line)

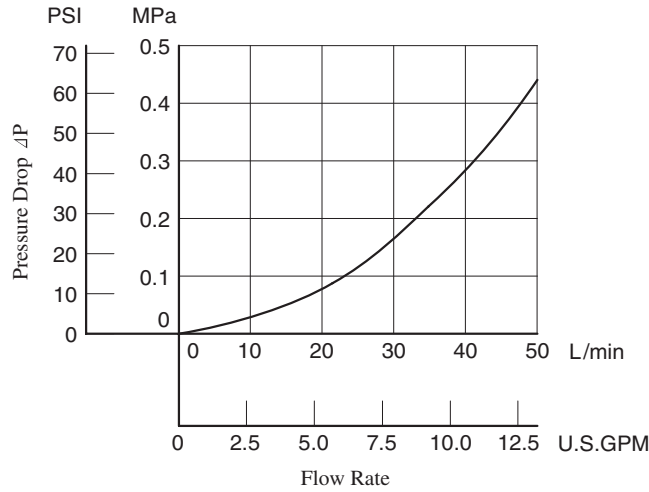

Pressure Drop

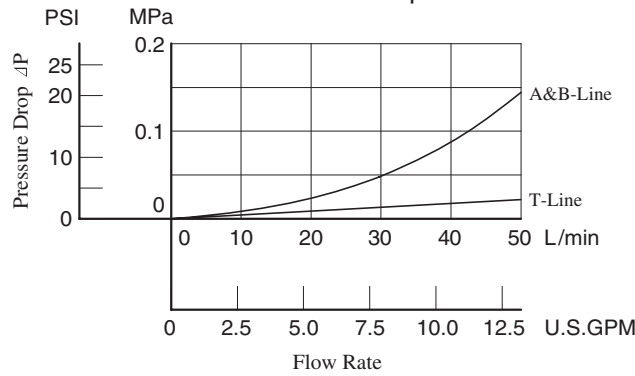

Min. Adjustment Pressure vs. Max. Flow

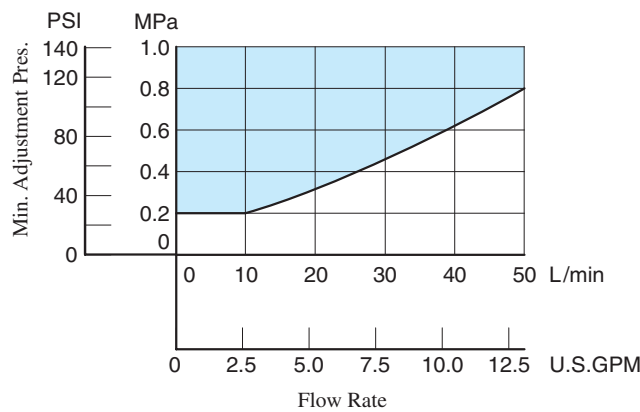

MRLP-03-10/1080/1090
MRLB-03-10/1080/1090

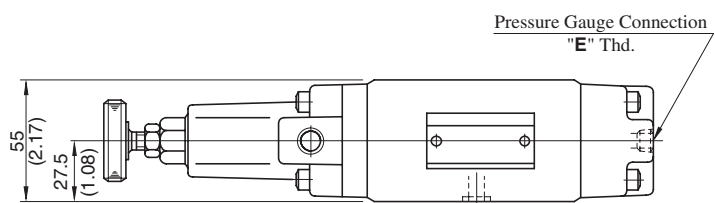
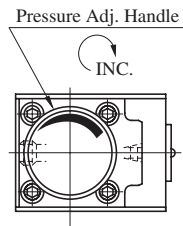
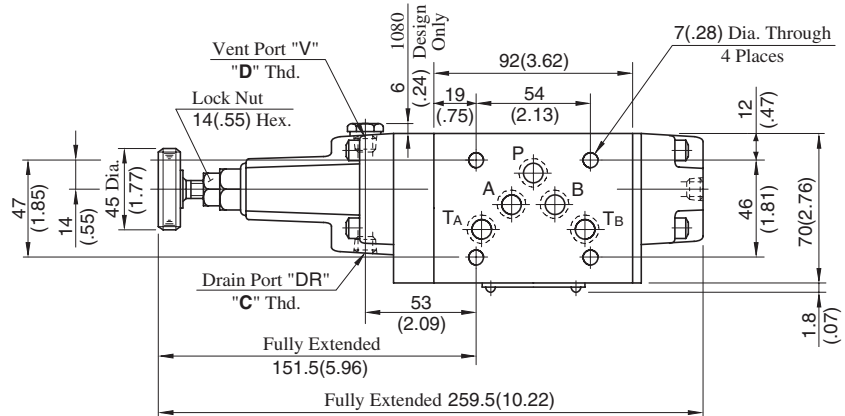

Approx. Mass.....4.5 kg (9.9 lbs.)

Model Numbers	Thread Size		
	"C" Thd.	"D" Thd.	"E" Thd.
MRL*-03-10	Rc 1/4	Rc 1/8	Rc 1/4
MRL*-03-1080	1/4 BSP.F	1/8 BSP.F	1/4 BSP.Tr
MRL*-03-1090	1/4 NPT	1/8 NPT	1/4 NPT

DIMENSIONS IN MILLIMETRES (INCHES)

MRLA-03-10/1080/1090

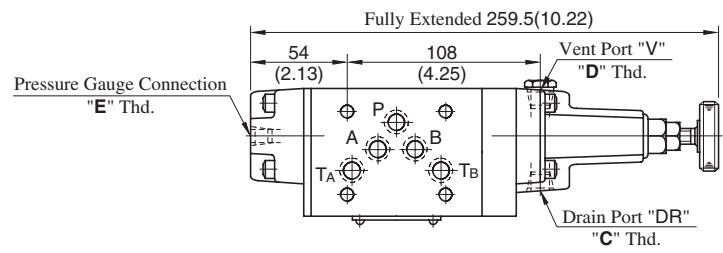

Approx. Mass.....4.5 kg (9.9 lbs.)

- For other dimensions, refer to "MRLP-03" drawing above.

Spare Parts List

MRLP-03-10/1080/1090
MRLB-03-10/1080/1090

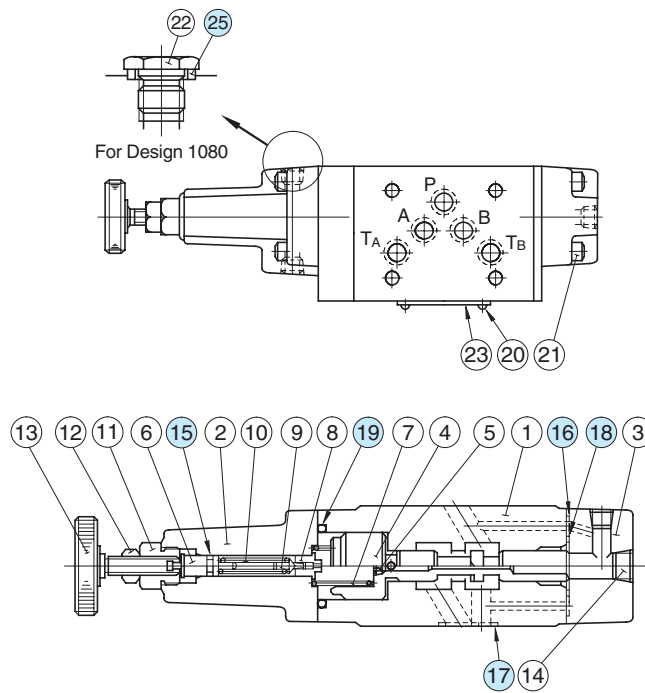

MRLA-03-10/1080/1090

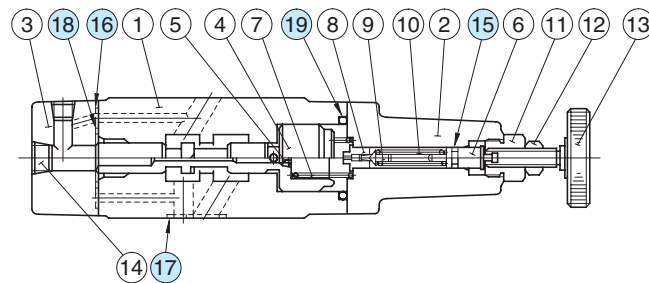

List of Seals

Item	Name of Parts	Part Numbers	Qty.	Remarks
15	O-Ring	SO-NA-P6	1	Included in Seal Kit Kit No.:KS-MRLP-03-10
16	O-Ring	SO-NB-P6	2	
17	O-Ring	SO-NB-A014	5	
18	O-Ring	SO-NB-P22	1	
19	O-Ring	SO-NB-P32	1	
25	Bonded Seal	SG-FB-1/8	1	

Note: No bonded seal are included in seal kits.

Sequence Modular Valves/Counterbalance Modular Valves

Specifications

Model Numbers	Max. Operating Pressure MPa (PSI)	Max. Flow L/min (U.S.GPM)	Max. Free Flow L/min (U.S.GPM)
MHP-03-*-20	25 (3630)	50 (13.2)	—
MHA-03-*-20 MHB-03-*-20			70 (18.5)

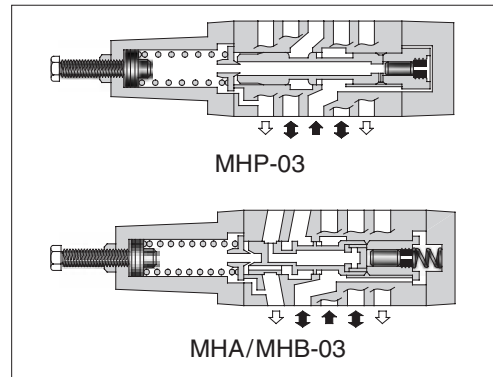

Model Number Designation

F-	MHA	-03	-C	-20	*
Special Seals	Series Number	Valve Size	Pres. Adj. Range MPa (PSI)	Design Number	Design Standard
F: Special Seals for Phosphate Ester Type Fluids (Omit if not required)	MHP: Sequence Valve for P-Line MHA: Counterbalance Valve for A-Line MHB: Counterbalance Valve for B-Line	03	N: *-1.8 (*-260) ★ ¹ A: 1.8-3.5 (260-510) B: 3.5-7 (510-1020) C: 7-14 (1020-2030)	20 20	Refer to ★ ²

★¹. See the "Minimum Adjustment Pressure" of the next page for the item marked *.

★². Design Standards: None Japanese Standard "JIS", European Design Standard and N. American Design Standard

Instructions

- The minimum adjustment pressure equals the value obtained from the minimum adjustment pressure characteristics plus the tank line back pressure of the next page. This back pressure should include the value of the T-line pressure drop characteristics of the valves stacked to the base plate side of the modular valve.
- To make pressure adjustment, loosen the lock nut and turn the pressure adjustment screw clockwise or anti-clockwise. For an increase of pressure, turn the screw clockwise. Be sure to re-tighten the lock nut firmly after making adjustment to the pressure.

Model Numbers	Graphic Symbols	Detailed Graphic Symbols
MHP-03		
MHA-03		
MHB-03		

Typical Performance Characteristics

Hydraulic Fluid: Viscosity 35 mm²/s (164 SSU), Specific Gravity 0.850

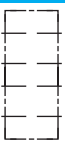
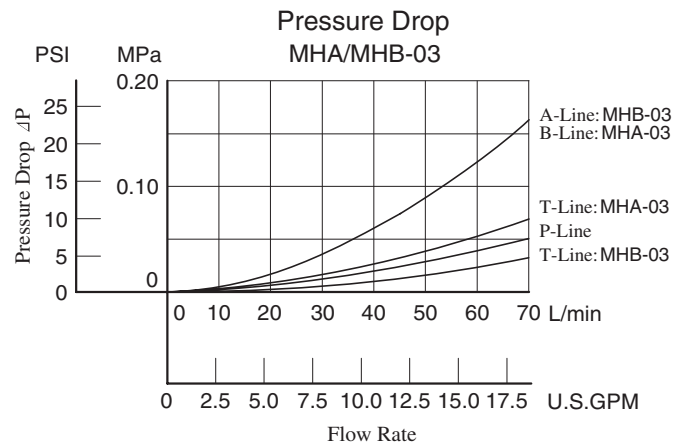
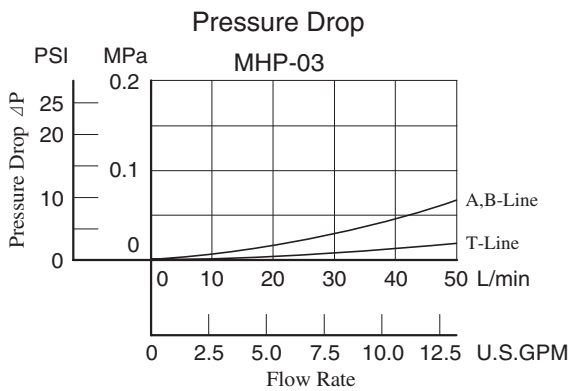
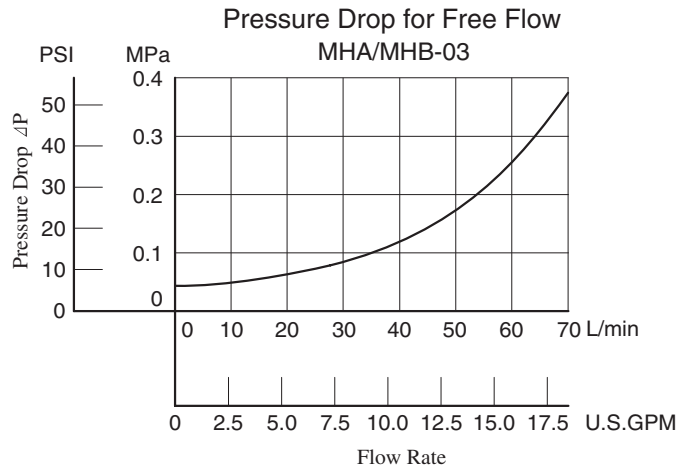
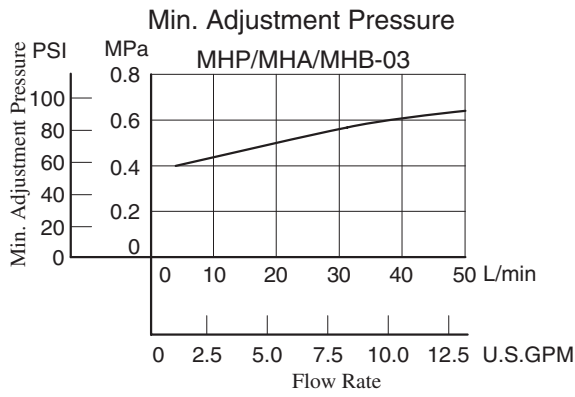

MHP-03-*-20

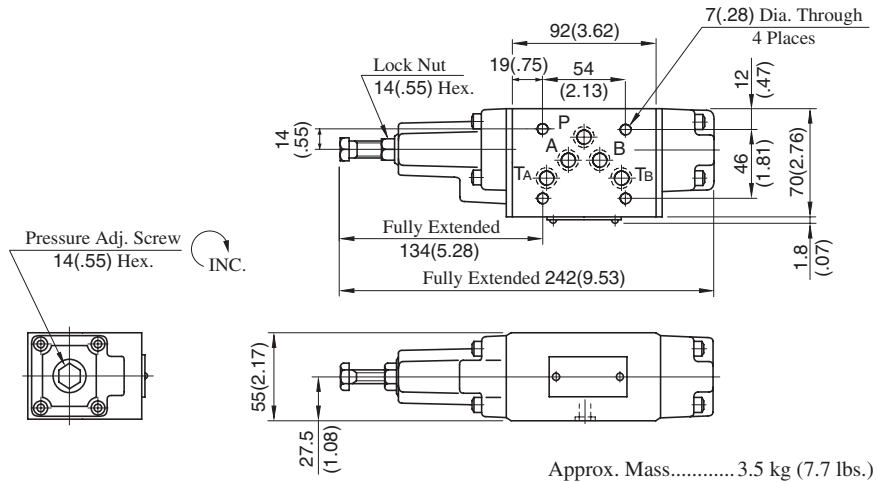

DIMENSIONS IN MILLIMETRES (INCHES)

MHA-03-*-20

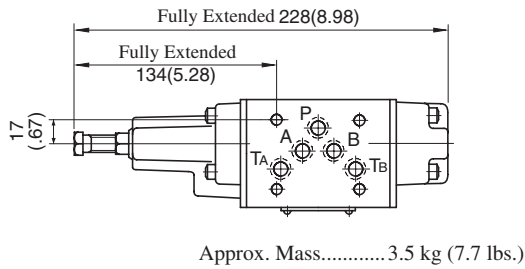

MHA-03-*-20

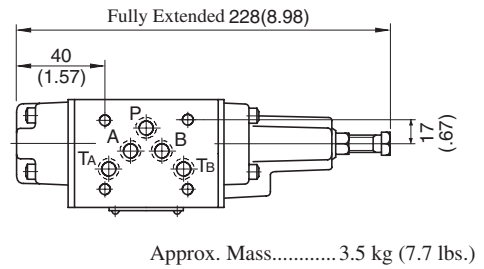

• For other dimensions, refer to "MHP-03" drawing above.

■ Spare Parts List

MHP-03-*-20

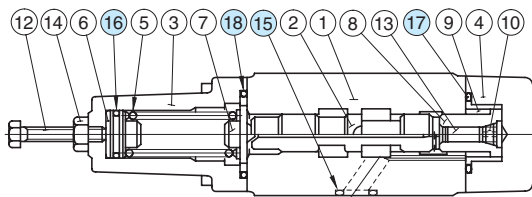

• List of Seals
MHP-03, MHA-03

Item	Name of Parts	Part Numbers	Qty.	Remarks
15	O-Ring	SO-NB-A014	5	Included in Seal Kit Kit No.:KS-MHP-03-20
16	O-Ring	SO-NB-P16	1	
17	O-Ring	SO-NB-P29	1	
18	O-Ring	SO-NB-P32	1	

MHA-03-*-20

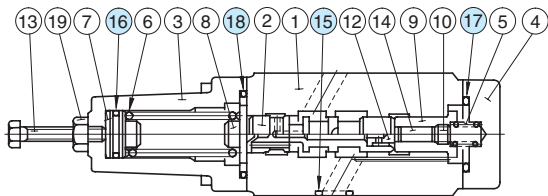

MHB-03-*-20

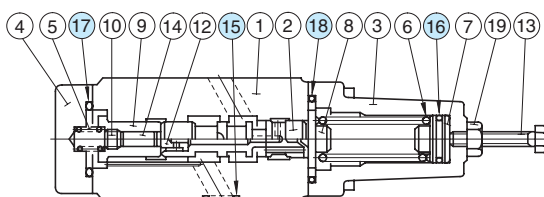

MHB-03

Item	Name of Parts	Part Numbers	Qty.	Remarks
15	O-Ring	SO-NB-A014	5	Included in Seal Kit Kit No.:KS-MHB-03-20
16	O-Ring	SO-NA-P16	1	
17	O-Ring	SO-NB-P29	1	
18	O-Ring	SO-NB-P32	1	

Pressure and Temperature Compensated Flow Control (and Check) Modular Valves

Specifications

Model Numbers	Max. Operating Pressure MPa (PSI)	Max. Metred Flow L/min (U.S.GPM)	Max. Free Flow L/min (U.S.GPM)
MFP-03-11	16 (2320)	50 (13.2)	—
MFA-03-*-11 MFB-03-*-11 MFW-03-*-11			70 (18.5)

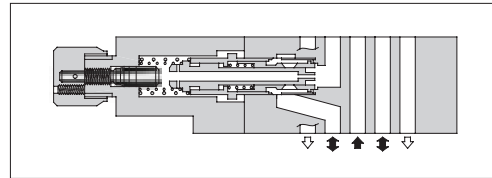

Model Number Designation

F-	MFA	-03	-X	-11	*
Special Seals	Series Number	Valve Size	Direction of Flow	Design Number	Design Standard
F: Special Seals for Phosphate Ester Type Fluids (Omit if not required)	MFP : Flow Control Valve for P-Line	03	—	11	Refer to ★
	MFA : Flow Control and Check Valve for A-Line MFB : Flow Control and Check Valve for B-Line MFW : Flow Control and Check Valve for A&B-Lines		X : Metre-out Y : Metre-in	11	

★ Design Standards: None Japanese Standard "JIS", European Design Standard and N. American Design Standard

Instructions

- To make flow rate adjustment, loosen locking screw for the dial and turn the flow adjustment dial clockwise or anti-clockwise. For a decrease of flow, turn the dial clockwise. Be sure to re-tighten the locking screw firmly after the adjustment of the flow rate.

Model No.	Graphic Symbols	Detailed Graphic Symbols	Model No.	Graphic Symbols	Detailed Graphic Symbols
MFP-03					
Model No.	Metre-out		Metre-in		
MFA-03-X			MFA-03-Y		
MFB-03-X			MFB-03-Y		
MFW-03-X			MFW-03-Y		

Typical Performance Characteristics

Hydraulic Fluid: Viscosity 35 mm²/s (164 SSU), Specific Gravity 0.850

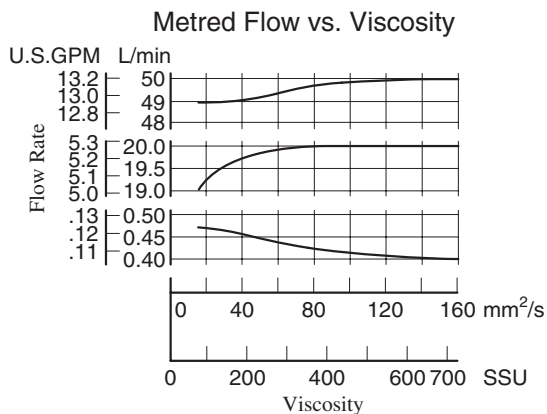
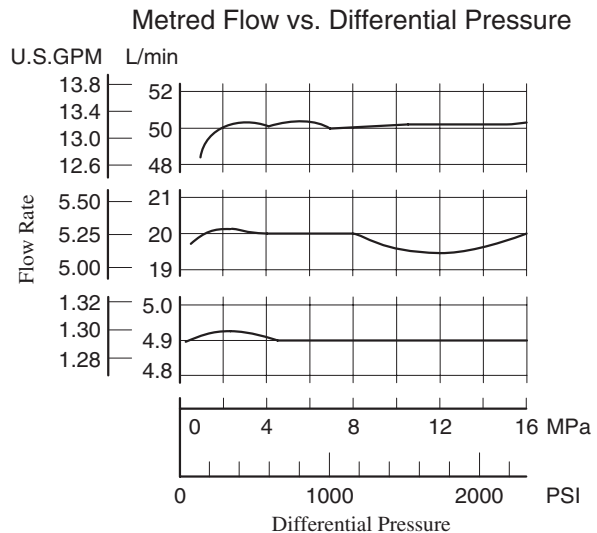
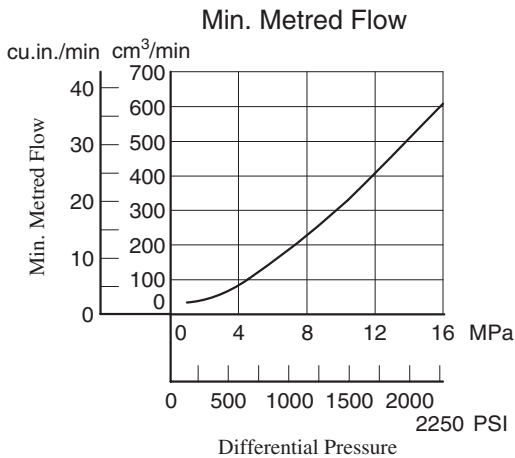
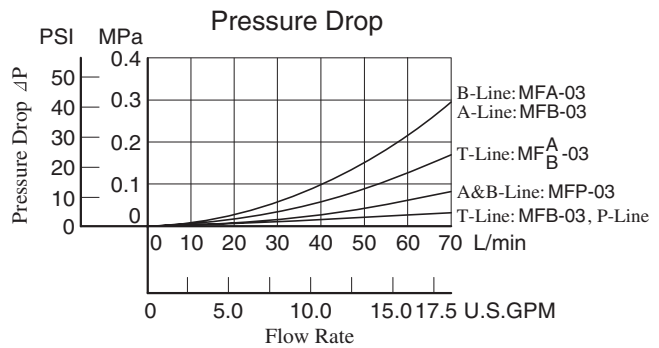
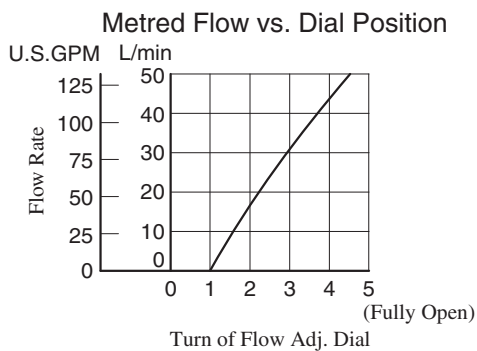
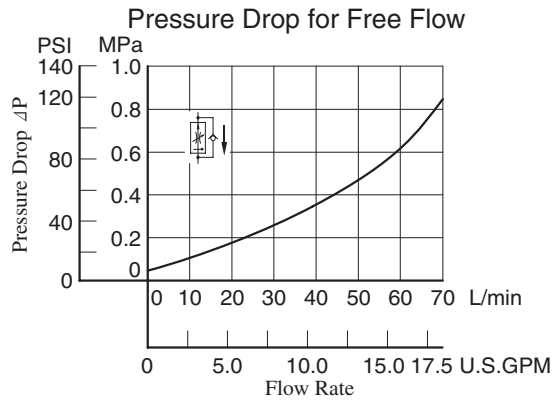
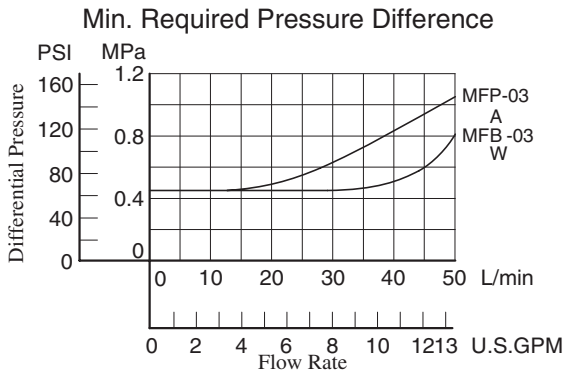

MFP-03-11

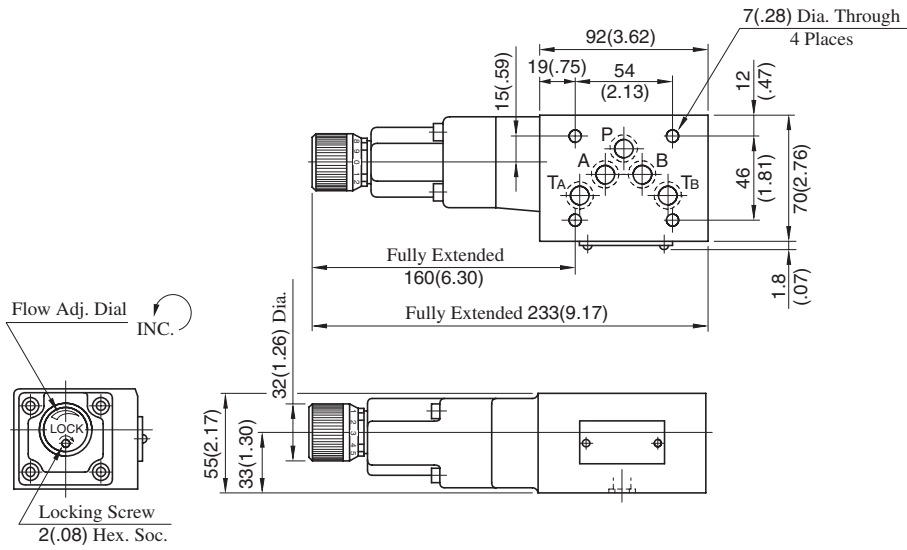

Approx. Mass.....4.2 kg (9.3 lbs.)

MFW-03-X-11

DIMENSIONS IN MILLIMETRES (INCHES)

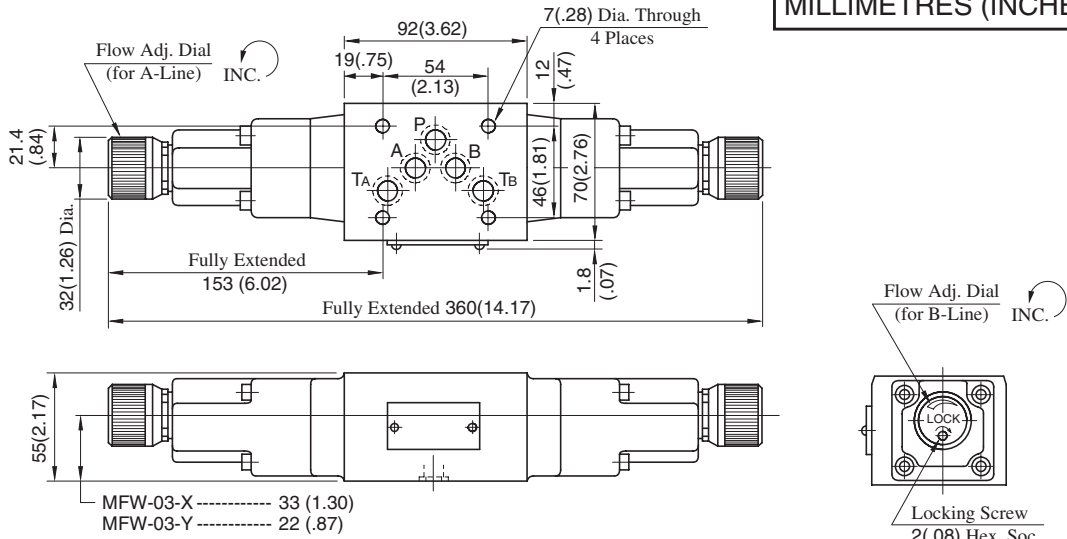

Approx. Mass.....5.2 kg (11.5 lbs.)

MFA-03-X-11

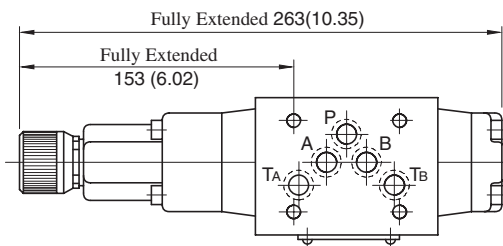

Approx. Mass.....4.1 kg (9.0 lbs.)

MFB-03-X-11

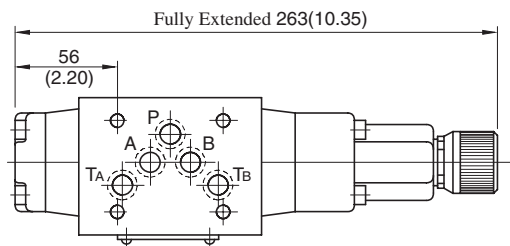

Approx. Mass.....4.1 kg (9.0 lbs.)

• For other dimensions, refer to "MFW-03" drawing above.

■ Spare Parts List

MFP-03-11

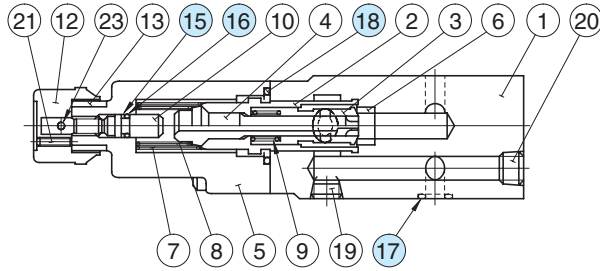

MFA-03-X_Y-11

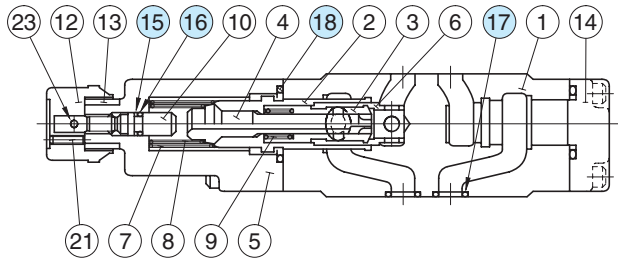

MFB-03-X_Y-11

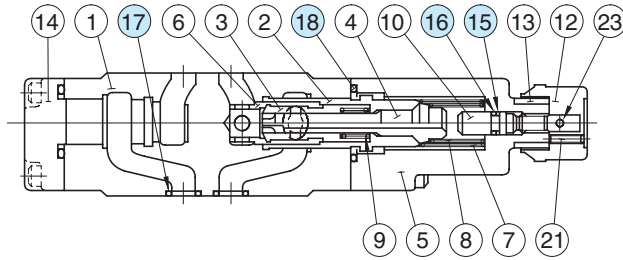

MFW-03-X_Y-11

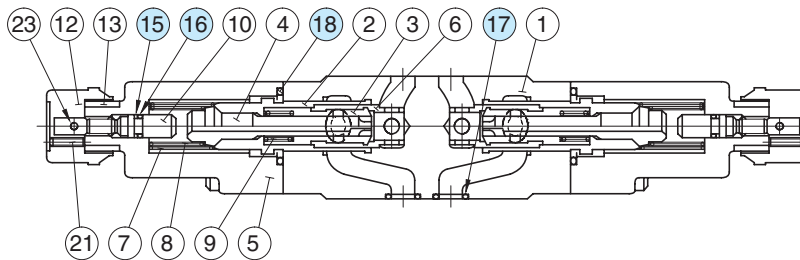

● List of Seals

Item	Name of Parts	Part Numbers	Quantity			
			MFP-03	MFA-03	MFB-03	MFW-03
15	Back Up Ring	SO-BB-P6	1	1	1	2
16	O-Ring	SO-NA-P6	1	1	1	2
17	O-Ring	SO-NB-A014	5	5	5	5
18	O-Ring	SO-NB-P28	1	2	2	2

● List of Seal Kits

Valve Model Numbers	Seal Kit Numbers
MFP-03	KS-MFP-03-10
MFA-03	KS-MFA-03-10
MFB-03	
MFW-03	KS-MFW-03-10

Note: When ordering seals, please specify the seal kit number from the table right.

Temperature Compensated Throttle and Check Modular Valves

Specifications

Model Numbers	Max. Operating Pressure	Max. Differential Pressure	Max. Metred Flow	Min. Metred Flow	Max. Free Flow
	MPa (PSI)	MPa (PSI)	L/min (U.S.GPM)	L/min (U.S.GPM)	L/min (U.S.GPM)
MSTA-03-X-20	25 (3630)	25 (3630)	70 (18.5)	2 (.53)	70 (18.5)
MSTB-03-X-20				{1 (.26)}*	
MSTW-03-X-20					

*The figures in parentheses are the values when the differential pressure is less than 3.5 MPa (510 PSI).

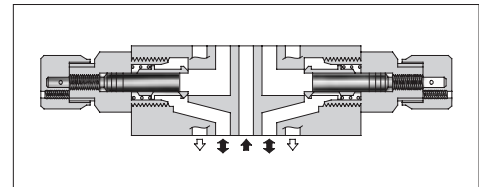

Model Number Designation

F-	MSTA	-03	-X	-20	*
Special Seals	Series Number	Valve Size	Direction of Flow	Design Number	Design Standard
F: Special Seals for Phosphate Ester Type Fluids (Omit if not required)	MSTA : Temperature Compensated Throttle and Check Valve for A-Line MSTB : Temperature Compensated Throttle and Check Valve for B-Line MSTW : Temperature Compensated Throttle and Check Valve for A&B-Lines	03	X : Metre-out	20	Refer to ★

★ Design Standards: None Japanese Standard "JIS", European Design Standard and N. American Design Standard

Instructions

- To make flow rate adjustment, loosen locking screw for the dial and turn the flow adjustment dial clockwise or anti-clockwise. For a decrease of flow, turn the dial clockwise. Be sure to re-tighten the locking screw firmly after the adjustment of the flow rate.

Model No.	Graphic Symbols	Detailed Graphic Symbols
	Metre-out	
MSTA-03-X		
MSTB-03-X		
MSTW-03-X		

Typical Performance Characteristics

Hydraulic Fluid: Viscosity 35 mm²/s (164 SSU), Specific Gravity 0.850

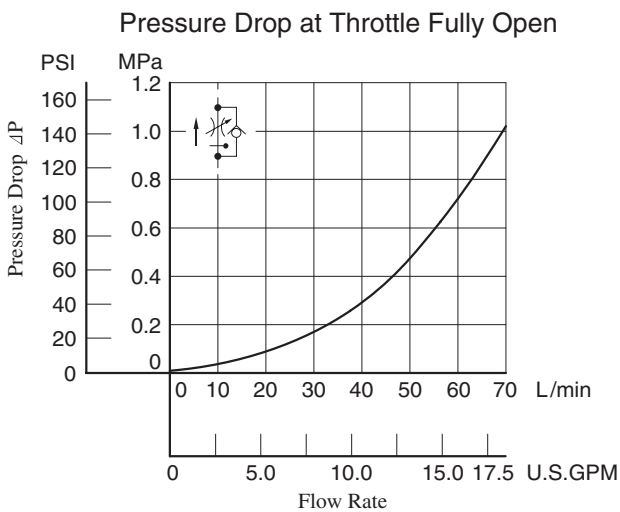
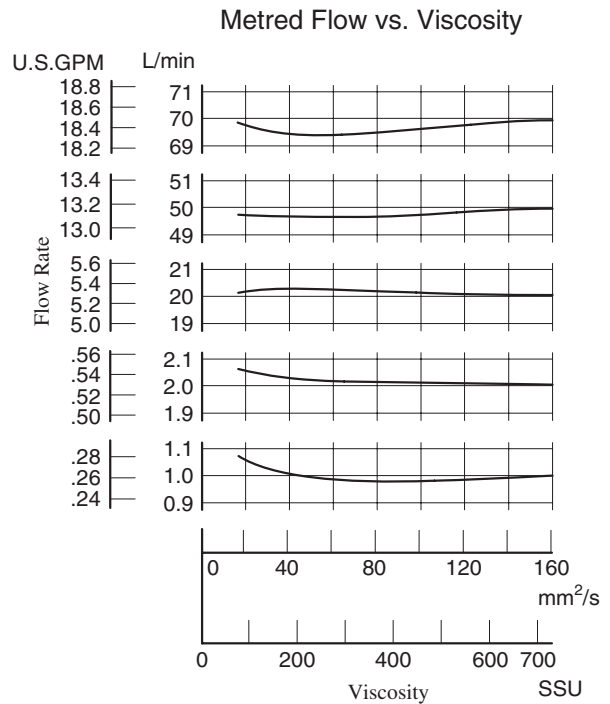
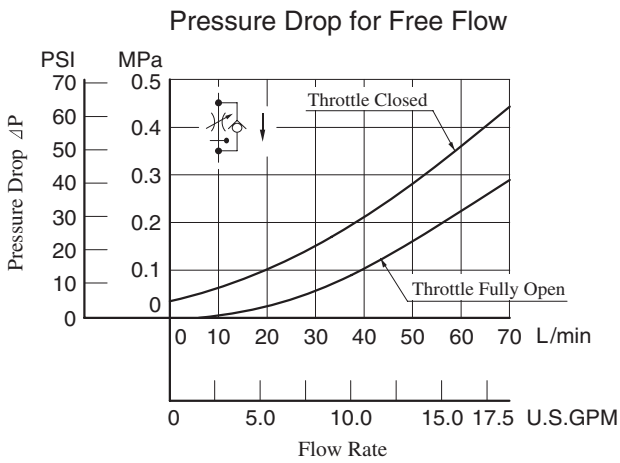
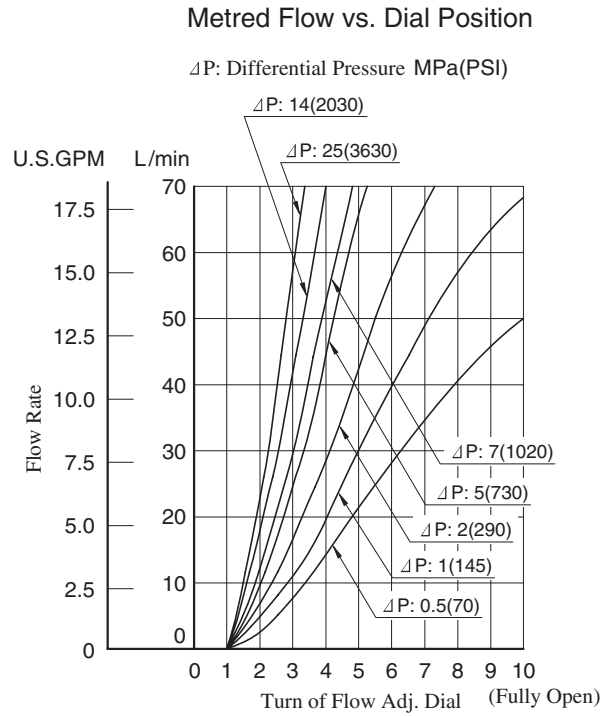
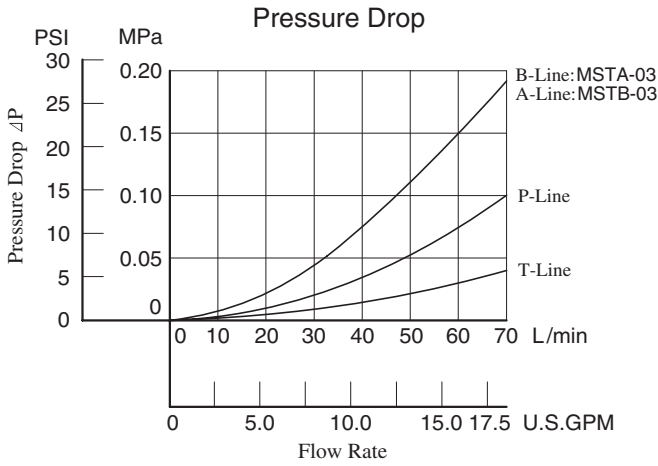

MSTW-03-X-20

**DIMENSIONS IN
MILLIMETRES (INCHES)**

Approx. Mass..... 3.7 kg (8.2 lbs.)

MSTA-03-X-20

Approx. Mass..... 3.5 kg (7.7 lbs.)

- For other dimensions, refer to "MSTW-03" drawing left.

MSTB-03-X-20

Approx. Mass..... 3.5 kg (7.7 lbs.)

- For other dimensions, refer to "MSTW-03" drawing left.

■ Spare Parts List

MSTA-03-X-20

MSTB-03-X-20

MSTW-03-X-20

- List of Seals

Item	Name of Parts	Part Numbers	Quantity		
			MSTA-03	MSTB-03	MSTW-03
12	Back Up Ring	900-VK411915-2	1	1	2
13	O-Ring	SO-NA-P7	1	1	2
14	O-Ring	SO-NB-A014	5	5	5
15	O-Ring	SO-NB-P24	2	2	2

Note: When ordering seals, please specify the seal kit number from the table right.

- List of Seal Kits

Valve Model Numbers	Seal Kit Numbers
MSTA-03	KS-MSTA-03-20
MSTB-03	
MSTW-03	KS-MSTW-03-20

Throttle Modular Valves

Specifications

Model Number	Max. Operating Pressure MPa (PSI)	Max. Flow L/min (U.S.GPM)
MSP-03-30	25 (3630)	70 (18.5) *

★ Maximum flow decreases when the differential pressure is less than 1 MPa (145 PSI).
See "Pressure Drop at Throttle Fully Open".

Model Number Designation

F-	MSP	-03	-30	*
Special Seals	Series Number	Valve Size	Design Number	Design Standard
F: Special Seals for Phosphate Ester Type Fluids (Omit if not required)	MSP : Throttle Valve for P-Line	03	30	Refer to ★

★ Design Standards: None Japanese Standard "JIS", European Design Standard and N. American Design Standard

Typical Performance Characteristics

Hydraulic Fluid: Viscosity 35 mm²/s (164 SSU), Specific Gravity 0.850

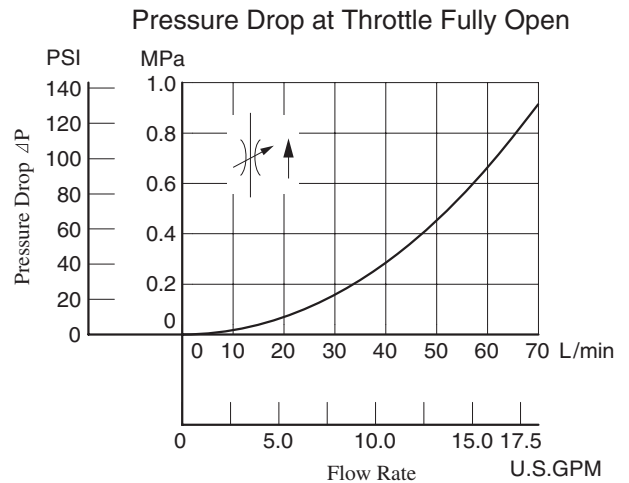
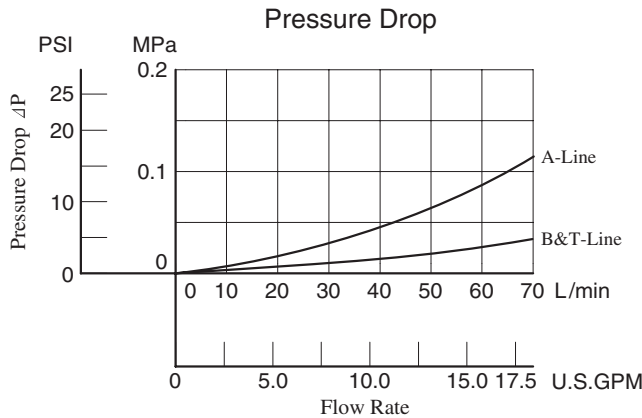

Metred Flow vs. Dial Position

ΔP: Differential Pressure MPa (PSI)

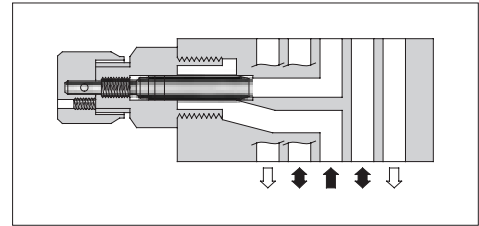
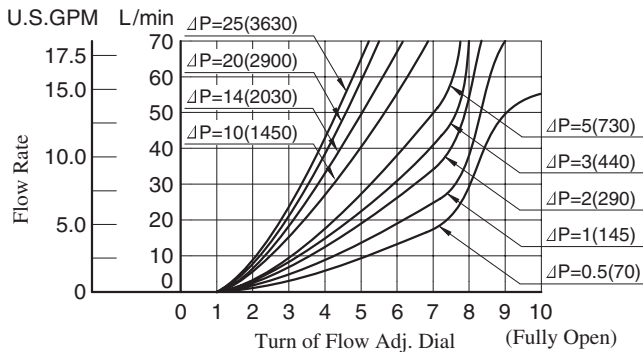

Graphic Symbol

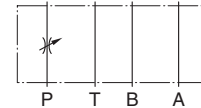

Detailed Graphic Symbol

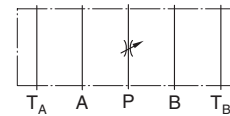

Instructions

- To make flow rate adjustment, loosen locking screw for the dial and turn the flow adjustment dial clockwise or anti-clockwise. For a decrease of flow, turn the dial clockwise. Be sure to re-tighten the locking screw firmly after the adjustment of the flow rate.

MSP-03-30

DIMENSIONS IN MILLIMETRES (INCHES)

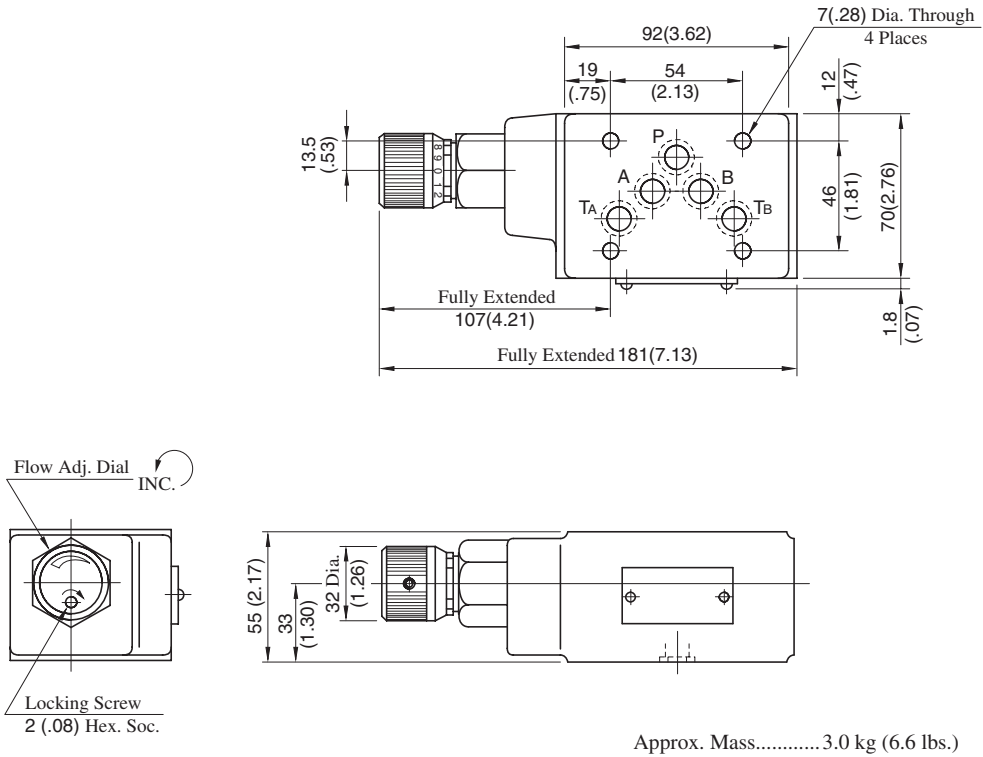

■ Spare Parts List

MSP-03-30

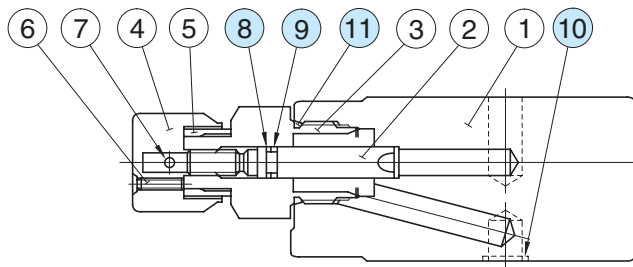

● List of Seals

Item	Name of Parts	Part Numbers	Qty.	Remarks
8	Back Up Ring	900-VK411915-2	1	Included in Seal Kit Kit No.: KS-MSP-03-30
9	O-Ring	SO-NA-P7	1	
10	O-Ring	SO-NB-A014	5	
11	O-Ring	SO-NB-P24	1	

Check and Throttle Modular Valves

Specifications

Model Number	Max. Operating Pressure MPa (PSI)	Max. Flow L/min (U.S.GPM)
MSCP-03-20	25 (3630)	70 (18.5) *

★ Maximum flow decreases when the differential pressure is less than 1 MPa (145 PSI).
See "Pressure Drop at Throttle Fully Open".

Model Number Designation

F-	MSCP	-03	-20	*
Special Seals	Series Number	Valve Size	Design Number	Design Standard
F: Special Seals for Phosphate Ester Type Fluids (Omit if not required)	MSCP : Check and Throttle Valve for P-Line	03	20	Refer to ★

★ Design Standards: None Japanese Standard "JIS", European Design Standard and N. American Design Standard

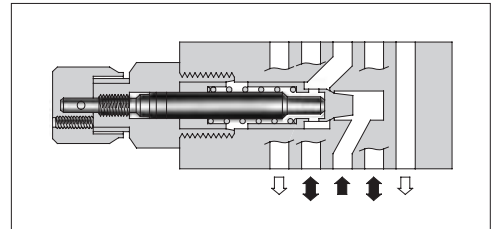
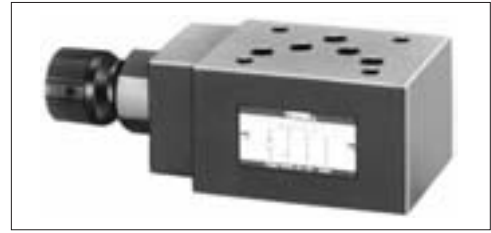

Graphic Symbol

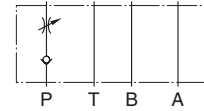

Detailed Graphic Symbol

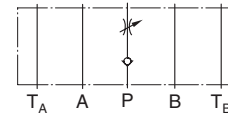

Typical Performance Characteristics

Hydraulic Fluid: Viscosity 35 mm²/s (164 SSU), Specific Gravity 0.850

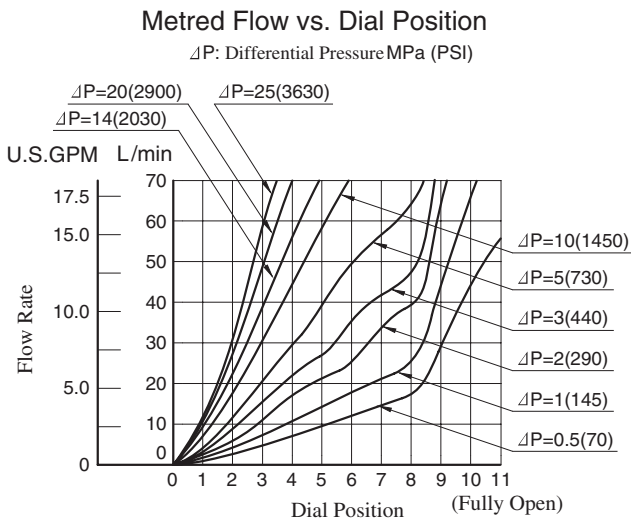
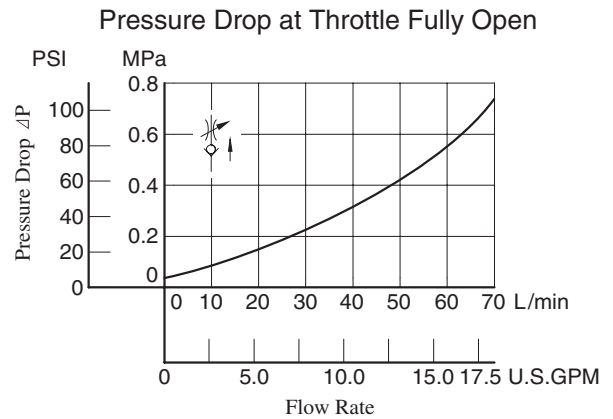
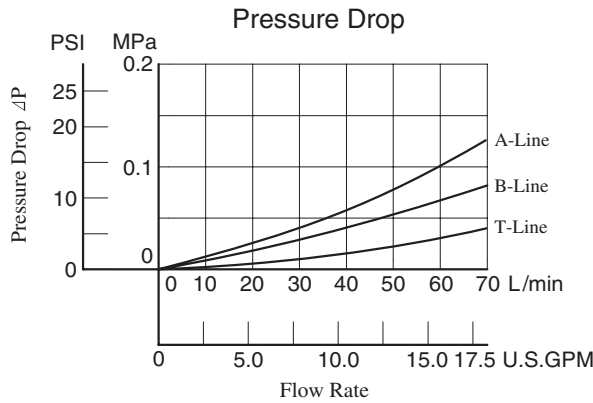

Instructions

- To make flow rate adjustment, loosen locking screw for the dial and turn the flow adjustment dial clockwise or anti-clockwise. For a decrease of flow, turn the dial clockwise. Be sure to re-tighten the locking screw firmly after the adjustment of the flow rate.

MSCP-03-20

**DIMENSIONS IN
MILLIMETRES (INCHES)**

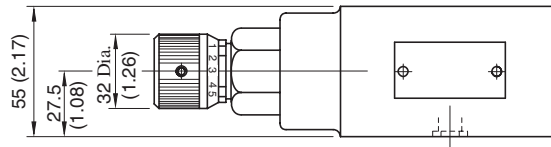
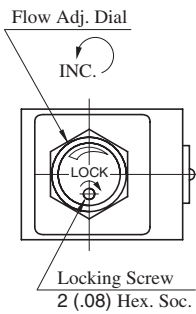
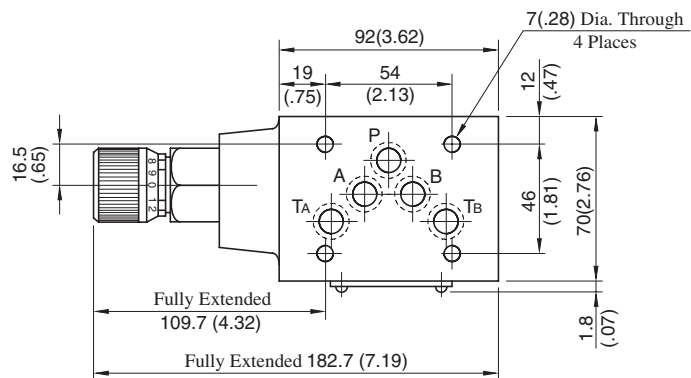

Approx. Mass..... 3.0 kg (6.6 lbs.)

■ Spare Parts List

MSCP-03-20

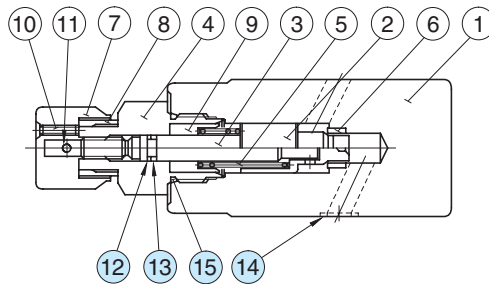

● List of Seals

Item	Name of Parts	Part Numbers	Qty.	Remarks
12	Back Up Ring	900-VK411915-2	1	Included in Seal Kit Kit No.: KS-MSP-03-30
13	O-Ring	SO-NA-P7	1	
14	O-Ring	SO-NB-A014	5	
15	O-Ring	SO-NB-P24	1	

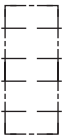

Throttle and Check Modular Valves

Specifications

Model Numbers	Max. Operating Pressure MPa (PSI)	Max. Flow L/min (U.S.GPM)
MSA-03-*-40 MSB-03-*-40 MSW-03-*-40	25 (3630)	120 (31.7)

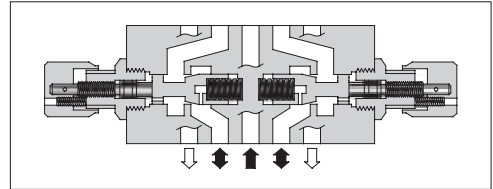

Model Number Designation

F-	MSW	-03	-X	-40	*
Special Seals	Series Number	Valve Size	Direction of Flow	Design Number	Design Standard
F: Special Seals for Phosphate Ester Type Fluids (Omit if not required)	MSA : Throttle and Check Valve for A-Line MSB : Throttle and Check Valve for B-Line MSW : Throttle and Check Valve for A&B-Lines	03	X : Metre-out Y : Metre-in	40	Refer to ★

★ Design Standards: None Japanese Standard "JIS", European Design Standard and N. American Design Standard

Instructions

- To make flow rate adjustment, loosen locking screw for the dial and turn the flow adjustment dial clockwise or anti-clockwise. For a decrease of flow, turn the dial clockwise. Be sure to re-tighten the locking screw firmly after the adjustment of the flow rate.

Model No.	Graphic Symbols	Detailed Graphic Symbols	Model No.	Graphic Symbols	Detailed Graphic Symbols
	Metre-out			Metre-in	
MSA-03-X			MSA-03-Y		
MSB-03-X			MSB-03-Y		
MSW-03-X			MSW-03-Y		

Typical Performance Characteristics

Hydraulic Fluid: Viscosity 35 mm²/s (164 SSU), Specific Gravity 0.850

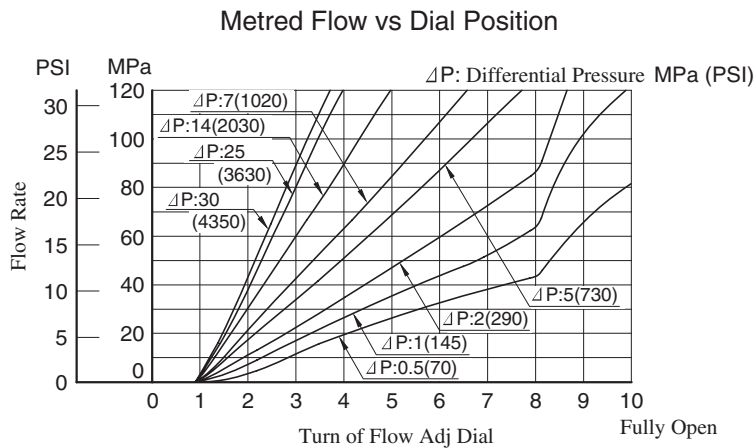
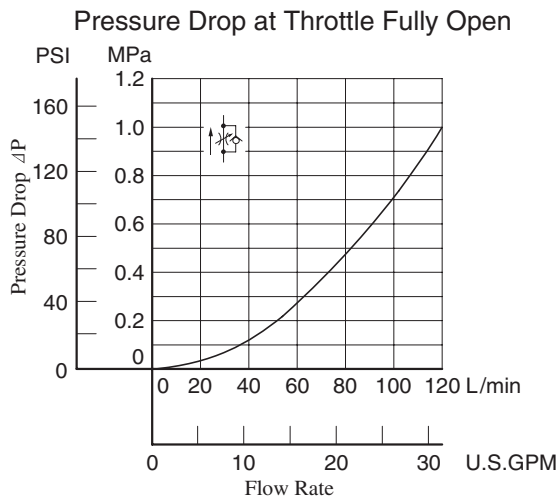
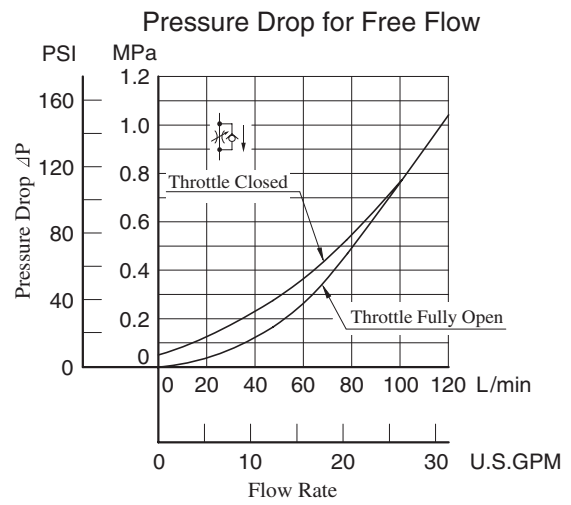
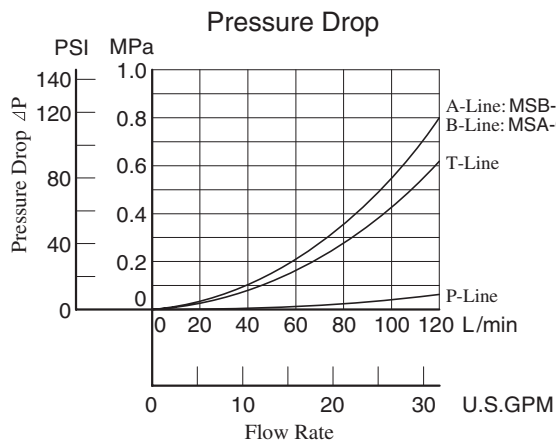

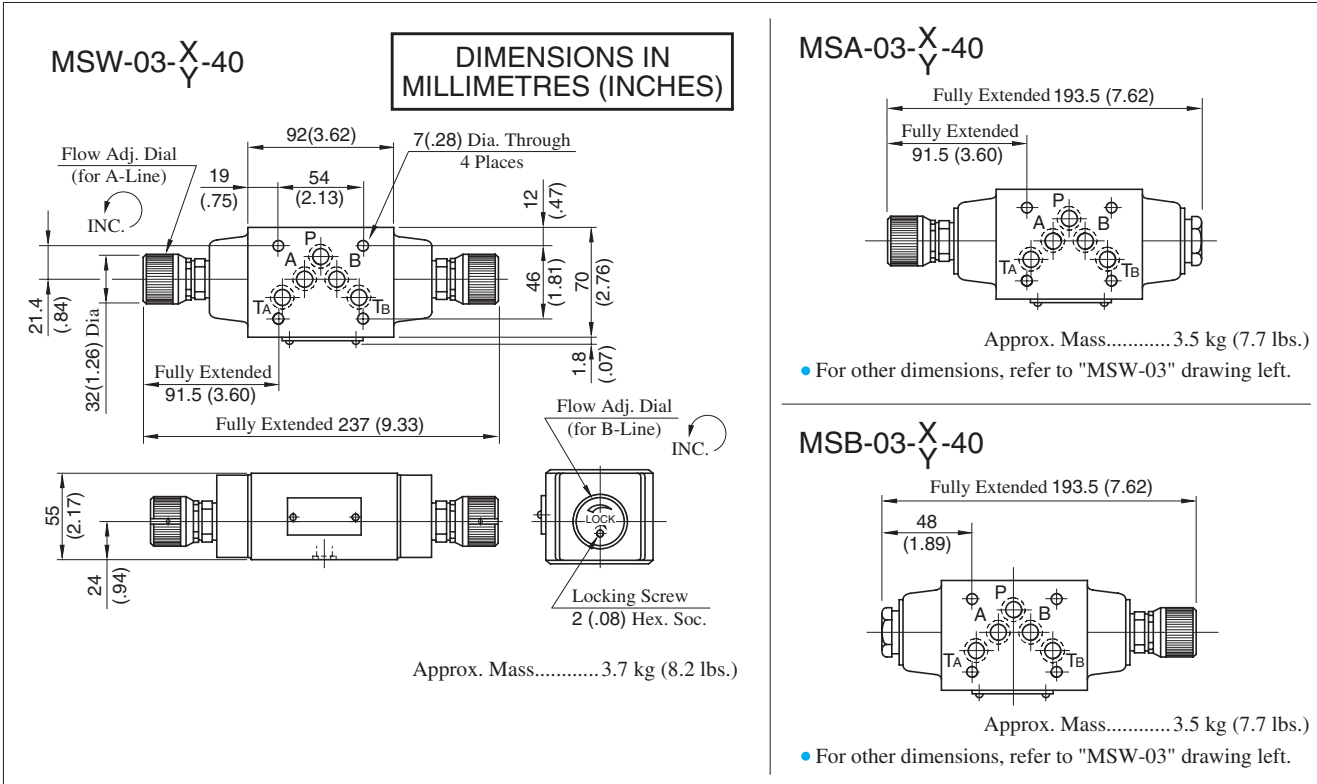

■ Spare Parts List

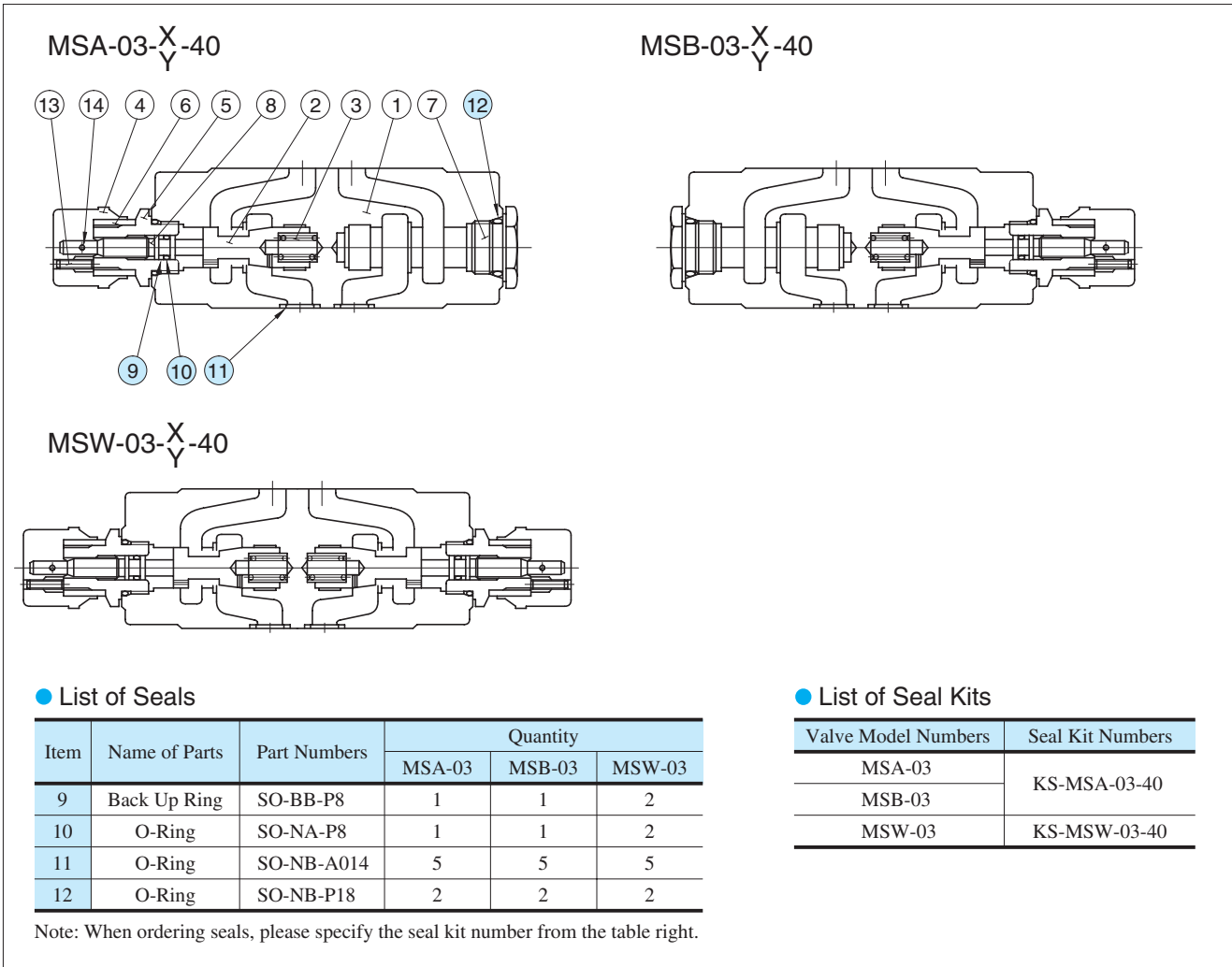

Check Modular Valves

Specifications

Model Numbers	Max. Operating Pressure MPa (PSI)	Max. Flow L/min (U.S.GPM)
MCP-03-*-10 MCA-03-*-20 MCB-03-*-20 MCT-03-*-10	25 (3630)	70 (18.5)

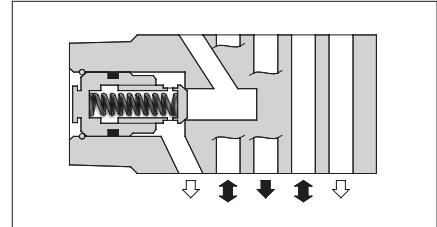

Model Number Designation

F-	MCP	-03	-0	-10	*
Special Seals	Series Number	Valve Size	Cracking Pressure MPa(PSI)	Design Number	Design Standard
F: Special Seals for Phosphate Ester Type Fluids (Omit if not required)	MCP: Check Valve for P-Line	03	0: 0.035(5) 2: 0.2(29)	10	Refer to ★
	MCA: Check Valve for A-Line MCB: Check Valve for B-Line			20	
	MCT: Check Valve for T-Line			10	

★ Design Standards: None Japanese Standard "JIS", European Design Standard and N. American Design Standard

Typical Performance Characteristics

Hydraulic Fluid: Viscosity 35 mm²/s (164 SSU), Specific Gravity 0.850

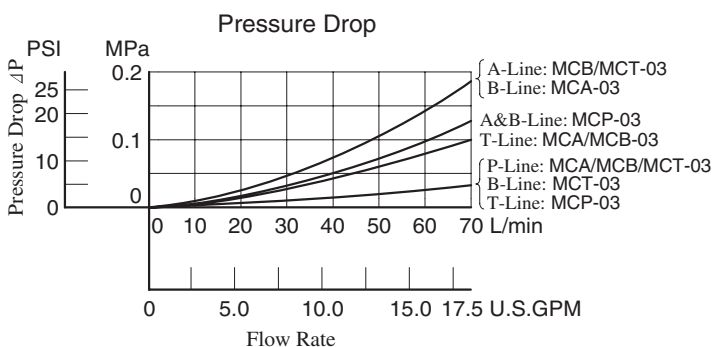
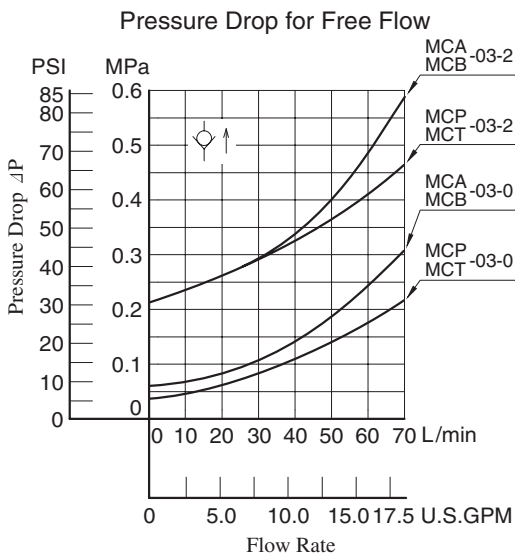

Model No.	Graphic Symbols	Detailed Graphic Symbols
MCP-03		
MCA-03		
MCB-03		
MCT-03		

Instructions

● Tank Line Used

Check valve function of MCT-03 is included in TA-Line. Therefore, the tank line for a circuit that uses this valve must be TA-line.

MCP-03-*-10

Approx. Mass.....2.5 kg (5.5 lbs.)

MCA-03-*-20 MCB-03-*-20

Approx. Mass.....3.5 kg (7.7 lbs.)

MCT-03-*-10

(Check valve is included)

Approx. Mass.....2.8 kg (6.2 lbs.)

DIMENSIONS IN MILLIMETRES (INCHES)

■ Spare Parts List

MCP-03-*-10

● List of Seals

Item	Name of Parts	Part Numbers	Qty.	Remarks
8	O-Ring	SO-NB-A014	5	Included in Seal Kit Kit No.: KS-MCP-03-10
9	O-Ring	SO-NB-P21	1	

MCT-03-*-10

● List of Seals

Item	Name of Parts	Part Numbers	Qty.	Remarks
7	O-Ring	SO-NB-A014	5	Included in Seal Kit Kit No.: KS-MCP-03-10
8	O-Ring	SO-NB-P21	1	

MCA-03-*-20

● List of Seals

Item	Name of Parts	Part Numbers	Qty.	Remarks
6	O-Ring	SO-NB-A014	5	Included in Seal Kit Kit No.: KS-MCA-03-20
7	O-Ring	SO-NB-P24	2	

MCB-03-*-20

Check Modular Valves For "P&T" Lines

Specifications

Model Numbers	Max. Operating Pressure MPa (PSI)	Max. Flow L/min (U.S.GPM)
MCPT-03-P*-T*-10	25 (3630)	70 (18.5)

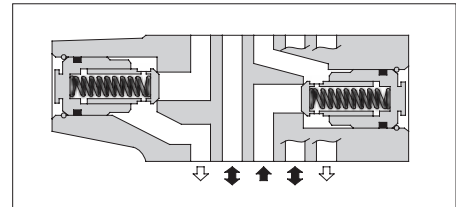

Model Number Designation

F-	MCPT	-03	-P0	-T0	-10	*
Special Seals	Series Number	Valve Size	Cracking Pres. of P-Line MPa(PSI)	Cracking Pres. of T-Line MPa(PSI)	Design Number	Design Standard
F : Special Seals for Phosphate Ester Type Fluids (Omit if not required)	MCPT : Check Valve for P&T-Lines	03	P0 : 0.035(5) P2 : 0.2(29)	T0 : 0.035(5) T2 : 0.2(29)	10	Refer to ★

★ Design Standards: None Japanese Standard "JIS", European Design Standard and N. American Design Standard

Typical Performance Characteristics

Hydraulic Fluid: Viscosity 35 mm²/s (164 SSU), Specific Gravity 0.850

Pressure Drop for Free Flow

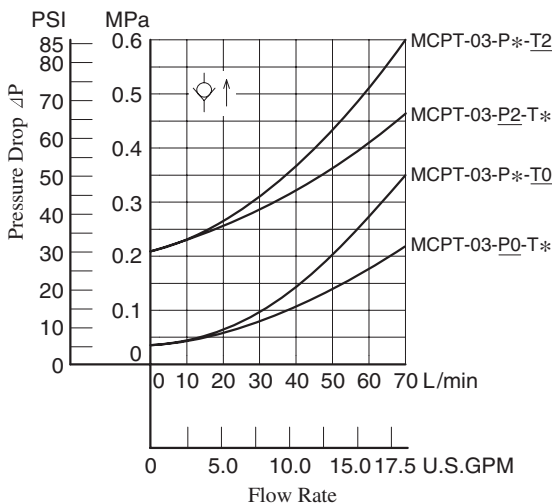

Pressure Drop

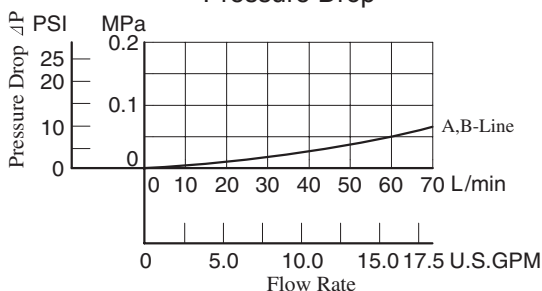

Graphic Symbol

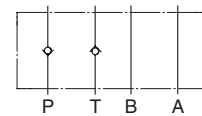

Detailed Graphic Symbol

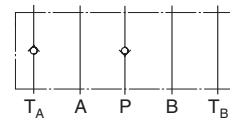

Instructions

● Tank Line Used

Check valve function of Tank Line is included in TA-Line. Therefore, the tank line for a circuit that uses this valve must be TA-line.

MCPT-03-P*-T*-10

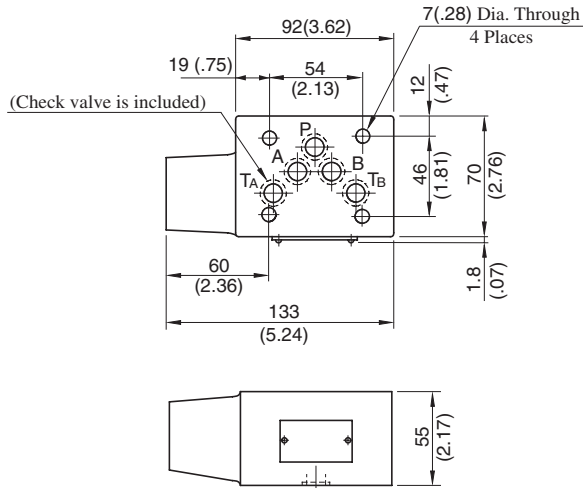

Approx. Mass.....2.7 kg (6.0 lbs.)

**DIMENSIONS IN
MILLIMETRES (INCHES)**

■ Spare Parts List

MCPT-03-P*-T*-10

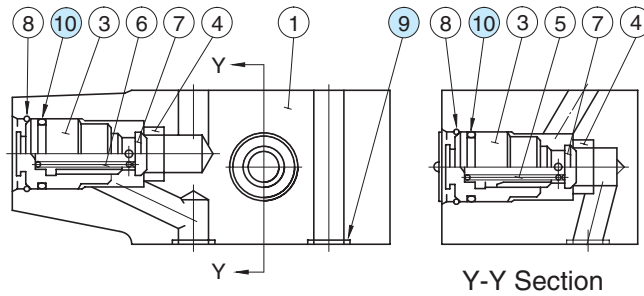

● List of Seals

Item	Name of Parts	Part Numbers	Qty.	Remarks
9	O-Ring	SO-NB-A014	5	Included in Seal Kit
10	O-Ring	SO-NB-P21	2	Kit No.: KS-MCPT-03-10

Anti-Cavitation Modular Valves

Specifications

Model Number	Max. Operating Pressure MPa (PSI)	Max. Flow L/min (U.S.GPM)
MAC-03-10	25 (3630)	70 (18.5)

Model Number Designation

F-	MAC	-03	-10	*
Special Seals	Series Number	Valve Size	Design Number	Design Standard
F: Special Seals for Phosphate Ester Type Fluids (Omit if not required)	MAC: Anti-Cavitation Valve	03	10	Refer to ★

★ Design Standards: None Japanese Standard "JIS", European Design Standard and N. American Design Standard

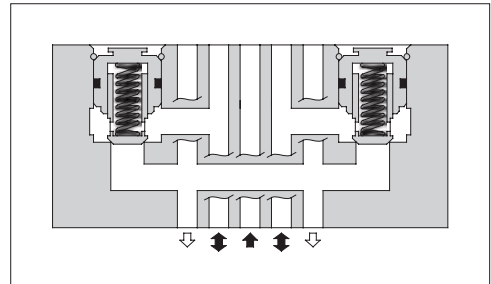

Pressure Drop

Hydraulic Fluid: Viscosity 35 mm²/s (164 SSU), Specific Gravity 0.850

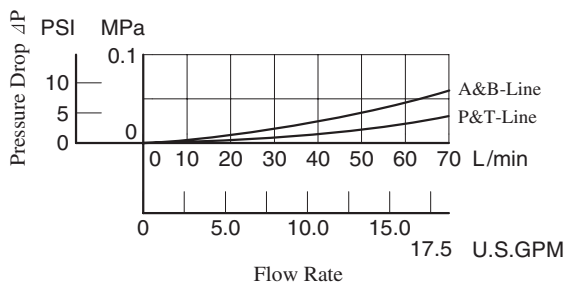

Graphic Symbol

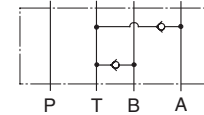

Detailed Graphic Symbol

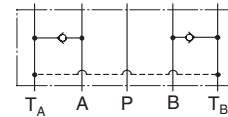

MAC-03-10

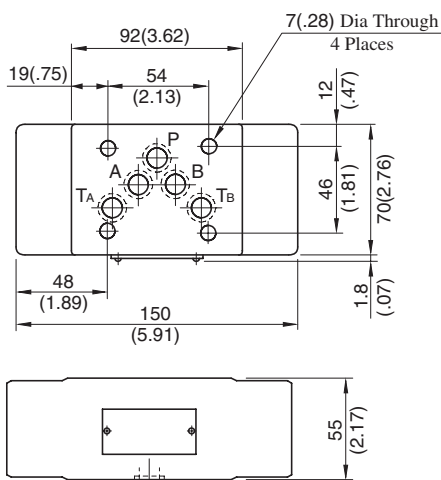

Approx. Mass.....3.8 kg (8.4 lbs.)

DIMENSIONS IN
MILLIMETRES (INCHES)

Spare Parts List

MAC-03-10

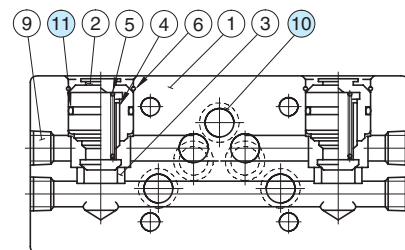

List of Seals

Item	Name of Parts	Part Numbers	Qty.	Remarks
10	O-Ring	SO-NB-A014	5	Included in Seal Kit
11	O-Ring	SO-NB-P21	2	Kit No.: KS-MAC-03-10

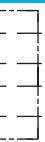

Pilot Operated Check Modular Valves

Specifications

Model Numbers		Max. Operating Pressure MPa (PSI)	Max. Flow L/min (U.S.GPM)
Standard	MP*-03-*-20	25 (3630)	70 (18.5)
Low Pilot Pressure Control Type	MP*-03-*-2001		



Model Number Designation

F-	MPA	-03	-2	-20	*
Special Seals	Series Number	Valve Size	Cracking Pressure MPa (PSI)	Design Number	Design Standard
F: Special Seals for Phosphate Ester Type Fluids (Omit if not required)	MPA : Pilot Operated Check Valve for A-Line MPB : Pilot Operated Check Valve for B-Line MPW : Pilot Operated Check Valve for A&B-Lines	03	2 : 0.2 (29) 4 : 0.4 (58)	20 (Standard) 2001 (Low Pilot Pressure Control Type)	Refer to ★

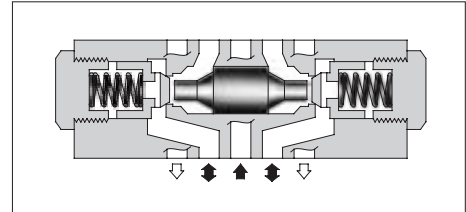

★ Design Standards: None Japanese Standard "JIS", European Design Standard and N. American Design Standard

Model No.	Graphic Symbols	Detailed Graphic Symbols
MPA-03		
MPB-03		
MPW-03		

Typical Performance Characteristics

Hydraulic Fluid: Viscosity 35 mm²/s (164 SSU), Specific Gravity 0.850

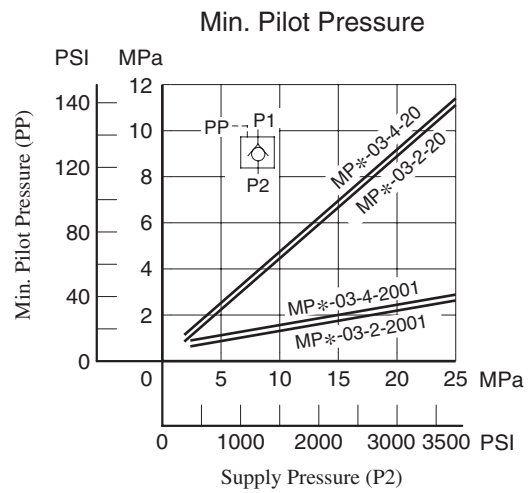
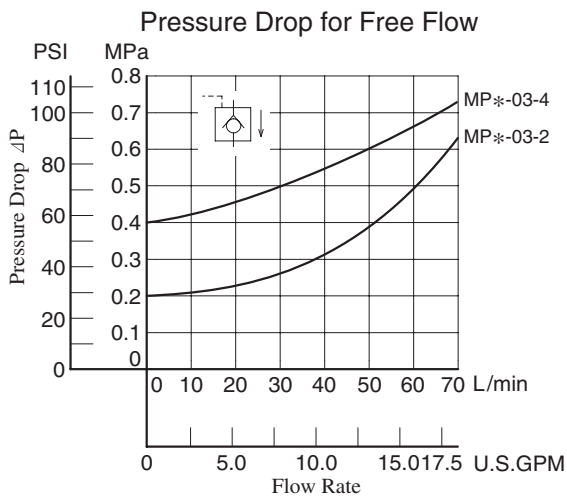
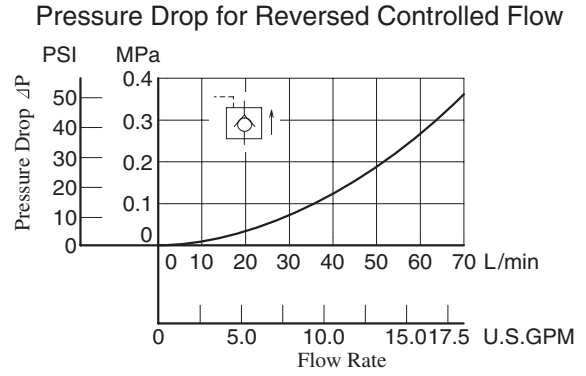
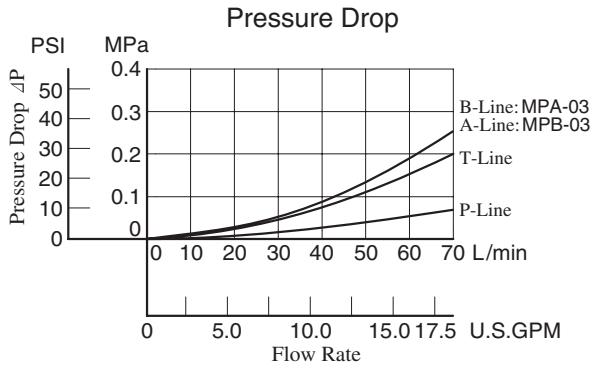

End Plates

Blocking plates are used for auxiliary mounting surfaces or for closing unnecessary circuit.

Bypass plates are used for one-way flow circuit that requires no solenoid operated directional valves.



Specifications

Model Numbers	Max. Operating Pressure MPa (PSI)	Max. Flow L/min (U.S.GPM)
MDC-03-*-10	25 (3630)	70 (18.5)

Model Number Designation

F-	MDC	-03	-A	-10	*
Special Seals	Series Number	Valve Size	Type of Plate	Design Number	Design Standard
F: Special Seals for Phosphate Ester Type Fluids (Omit if not required)	MDC: End Plate	03	A: Blocking Plate B: Bypass Plate	10	None: Japanese Standard "JIS", European Design Standard and N. American Design Standard

Pressure Drop

Hydraulic Fluid: Viscosity 35 mm²/s (164 SSU), Specific Gravity 0.850

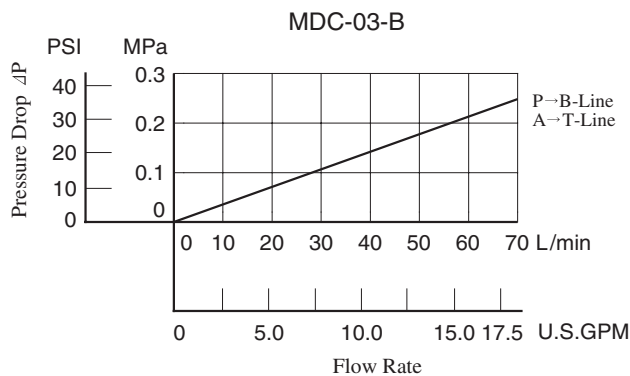

Model No.	Graphic Symbols	Detailed Graphic Symbols
MDC-03-A		
MDC-03-B		

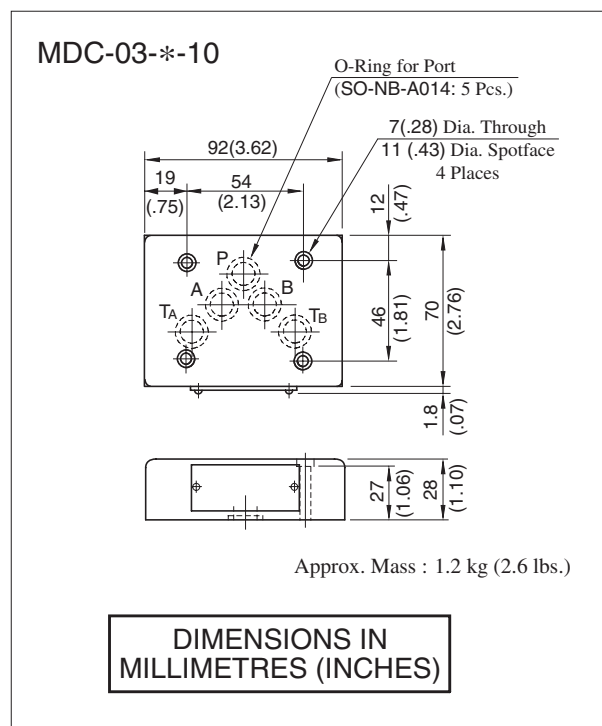

F
03 Series Modular Valves

Connecting Plates

Specifications

Model Numbers	Max. Operating Pressure MPa (PSI)	Max. Flow L/min (U.S.GPM)
MDS-03-10/1090	25 (3630)	70 (18.5)



Model Number Designation

F-	MDS	-03	-10	*
Special Seals	Series Number	Valve Size	Design Number	Design Standard
F: Special Seals for Phosphate Ester Type Fluids (Omit if not required)	MDS: Connecting Plate	03	10	None: Japanese Standard "JIS" and European design Standard 90: N.American Design Standard

Pressure Drop

Hydraulic Fluid: Viscosity 35 mm²/s (164 SSU), Specific Gravity 0.850

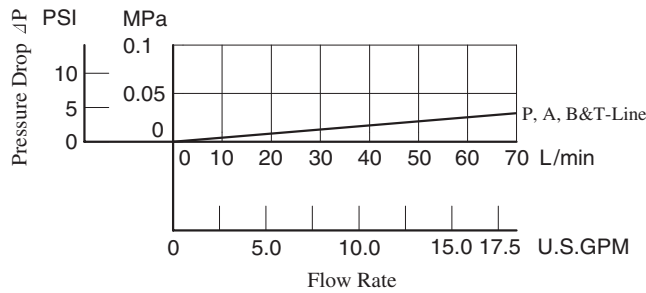

Graphic Symbol

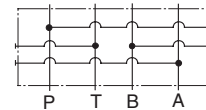

Detailed Graphic Symbol

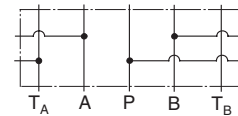

MDS-03-10/1090

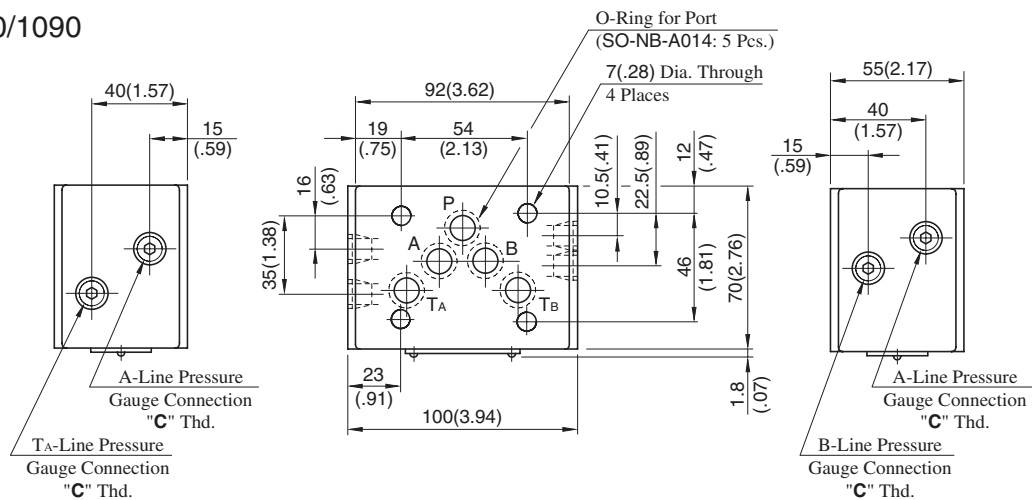

Approx. Mass.....2.5 kg (5.5 lbs.)

Model Numbers	Thread Size "C" Thd.
MDS-03-10	Rc 1/4 = 1/4 BSP.Tr
MDS-03-1090	1/4 NPT

DIMENSIONS IN MILLIMETRES (INCHES)

Base Plates For Modular Valves

Specifications

Max. Operating Pressure ----- 25 MPa (3630 PSI)

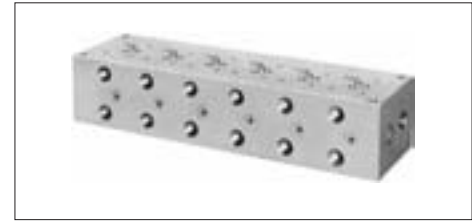

Model Number Designation

MMC	-03	-T	-6	-21	*	
Series Number	Plate Size	Type of Connection	Number of Stations	Design Number	Design Standard	
MMC : Base Plate	03	T : Threaded Connection	1: 1 Station 2: 2 Stations 3: 3 Stations 4: 4 Stations	5: 5 Stations 6: 6 Stations 7: 7 Stations	21 	None: Japanese Standard "JIS" 80: European Design Standard 90: N.American Design Standard

Pressure Drop

Hydraulic Fluid: Viscosity 35 mm²/s (164 SSU), Specific Gravity 0.850

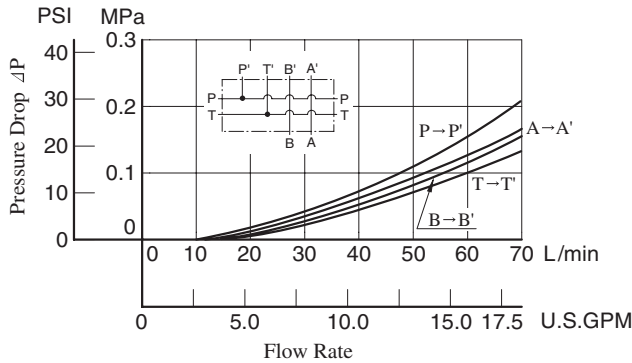

Graphic Symbol

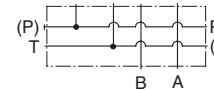

Detailed Graphic Symbol

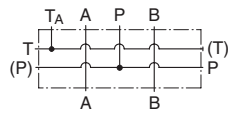

MMC-03-T-1

Graphic Symbol

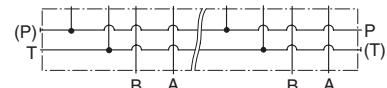

MMC-03-T-2-7

Mounting Surface Dimensions for 3/8 Modular Valve

When the standard base plate (MMC-03) is not used, the following mounting surface must be prepared. Also, the mounting surface must have a good machined finish.

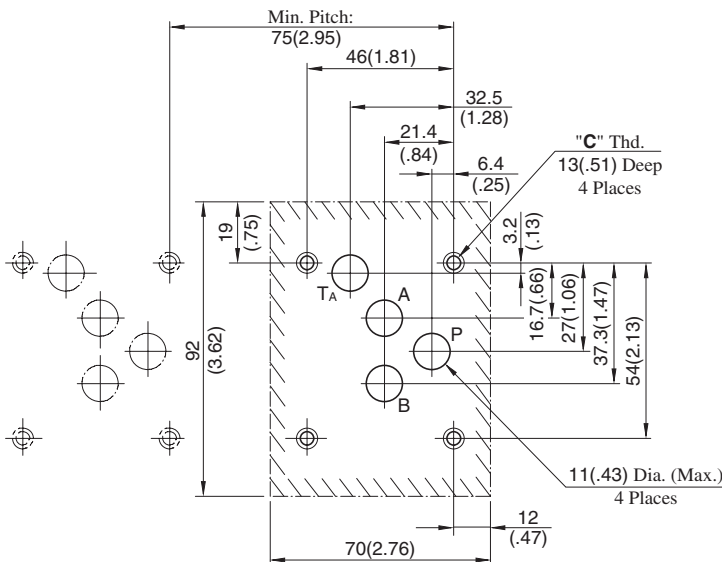

Instructions

- Although two ports are provided for both **pressure port "P"** and **tank port "T"**, either may be used.

However, the ports having (P) or (T) in the drawing are normally plugged. Remove the plugs of the ports when they are used. Make sure that the ports that are not currently used are properly plugged.

DIMENSIONS IN MILLIMETRES (INCHES)

Design Std.	"C" Thd.
Japanese Standard "JIS" and European Design Standard	M6
N.American Design Standard	1/4-20 UNC

MMC-03-T-1-21/2190

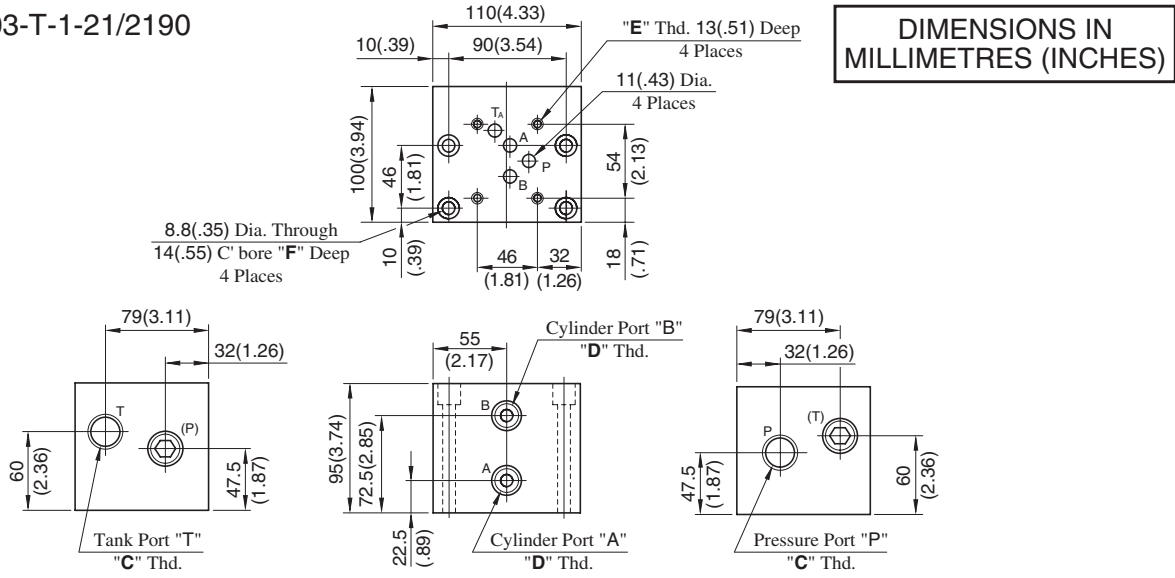

DIMENSIONS IN MILLIMETRES (INCHES)

MMC-03-T-*21/2190

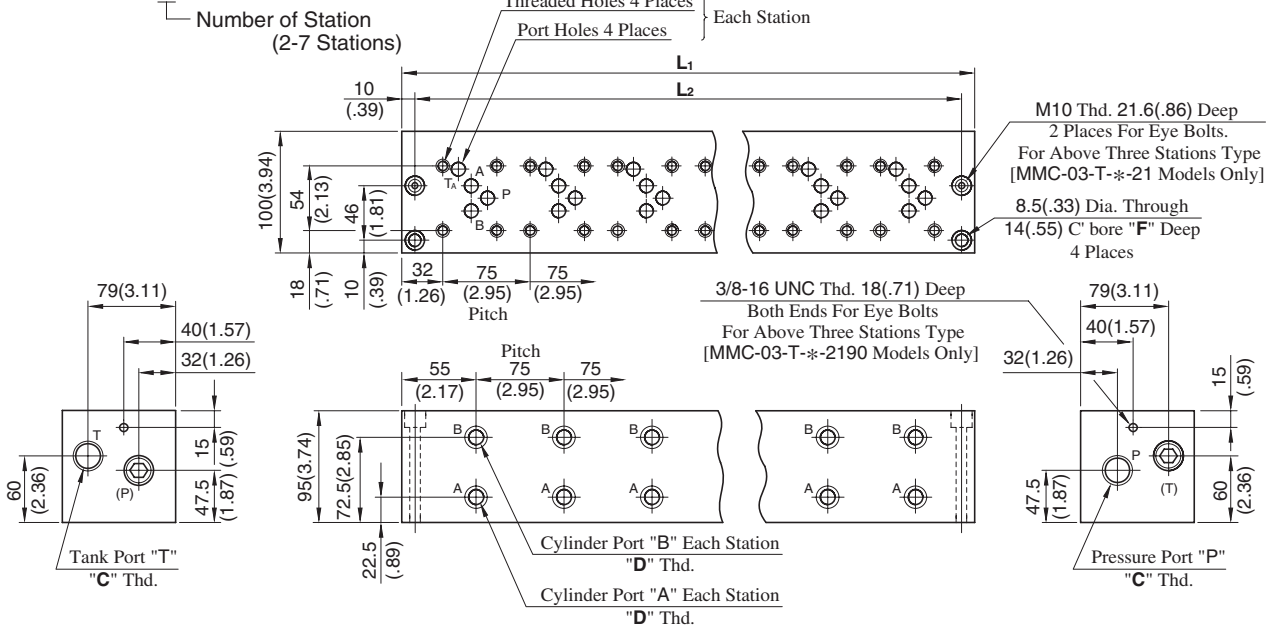

• For other dimensions, refer to above Model MMC-03-T-1.

Model Numbers	Thread Size			Dimensions mm (Inches)			Approx. Mass kg (lbs.)
	"C" Thd.	"D" Thd.	"E" Thd.	F	L1	L2	
MMC-03-T-1-21	Rc 3/4	Rc 1/2	M6	8.6 (.34)	—	—	8.5 (18.7)
MMC-03-T-1-2190	3/4 NPT	1/2 NPT	1/4-20 UNC	22 (.87)	—	—	—
MMC-03-T-2-21	Rc 3/4	Rc 1/2	M6	8.6 (.34)	185	165	14 (30.9)
MMC-03-T-2-2190	3/4 NPT	1/2 NPT	1/4-20 UNC	22 (.87)	(7.28)	(6.50)	—
MMC-03-T-3-21	Rc 3/4	Rc 1/2	M6	8.6 (.34)	260	240	19.5 (43.0)
MMC-03-T-3-2190	3/4 NPT	1/2 NPT	1/4-20 UNC	22 (.87)	(10.24)	(9.45)	—
MMC-03-T-4-21	Rc 3/4	Rc 1/2	M6	8.6 (.34)	335	315	25 (55.1)
MMC-03-T-4-2190	3/4 NPT	1/2 NPT	1/4-20 UNC	22 (.87)	(13.19)	(12.40)	—
MMC-03-T-5-21	Rc 3/4	Rc 1/2	M6	8.6 (.34)	410	390	30.5 (67.3)
MMC-03-T-5-2190	3/4 NPT	1/2 NPT	1/4-20 UNC	22 (.87)	(16.14)	(15.35)	—
MMC-03-T-6-21	Rc 3/4	Rc 1/2	M6	8.6 (.34)	485	465	36 (79.4)
MMC-03-T-6-2190	3/4 NPT	1/2 NPT	1/4-20 UNC	22 (.87)	(19.09)	(18.31)	—
MMC-03-T-7-21	Rc 3/4	Rc 1/2	M6	8.6 (.34)	560	540	41 (90.4)
MMC-03-T-7-2190	3/4 NPT	1/2 NPT	1/4-20 UNC	22 (.87)	(22.05)	(21.26)	—

MMC-03-T-1-2180

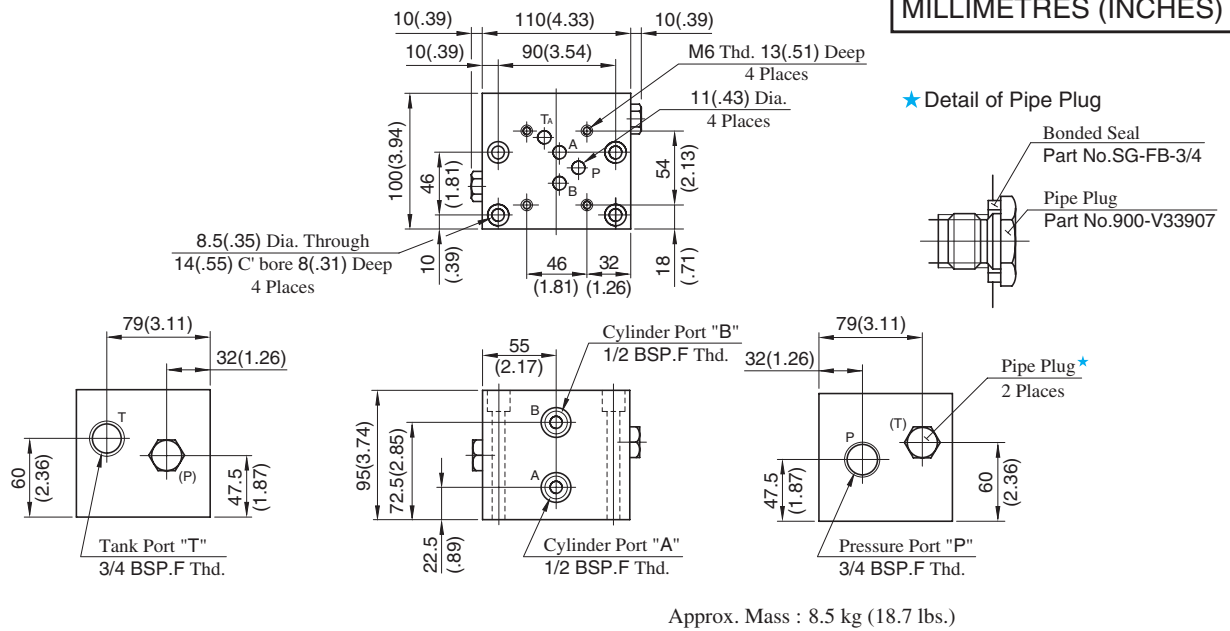

MMC-03-T-*2180

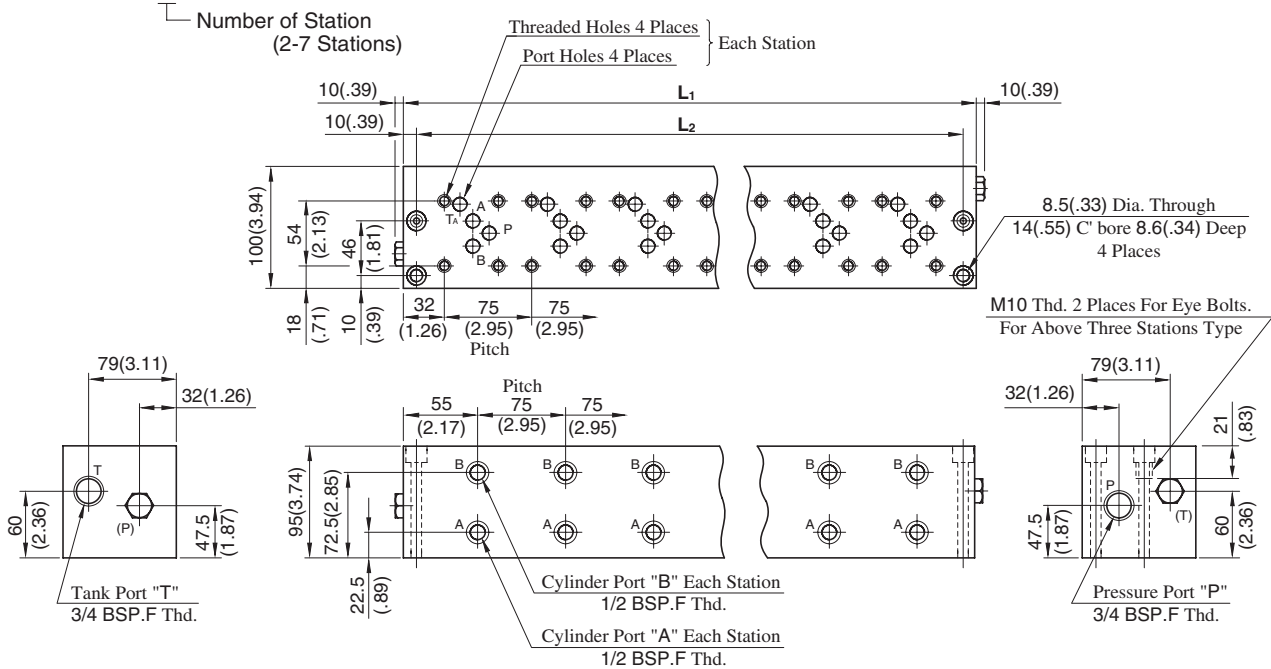

• For other dimensions, refer to above Model MMC-03-T-1.

Model Numbers	Dimensions mm (Inches)		Approx. Mass kg (lbs.)
	L ₁	L ₂	
MMC-03-T-2-2180	185 (7.28)	165 (6.50)	14 (30.9)
MMC-03-T-3-2180	260 (10.24)	240 (9.45)	19.5 (43.0)
MMC-03-T-4-2180	335 (13.19)	315 (12.40)	25 (55.1)
MMC-03-T-5-2180	410 (16.14)	390 (15.35)	30.5 (67.3)
MMC-03-T-6-2180	485 (19.09)	465 (18.31)	36 (79.4)
MMC-03-T-7-2180	560 (22.05)	540 (21.26)	41 (90.4)



Mounting Bolt Kits For Modular Valves

Valves are mounted with four stud bolts. Valve combination varies according to the circuit type. Hence, the mounting bolt kits are available on a combination type basis. When ordering the mounting bolt kit, be sure to give the bolt kit model number from the table below.



Model Number Designation

MBK	-03	-04	-10	*
Series Number	Size of Modular Valve	Bolt Number	Design Number	Design Standard
MBK: Mounting Bolt Kits for Modular Valve	03	01, 02, 03, 04, 05 (Refer to the following chart)	10	Refer to ★

★ Design Standards: None Japanese Standard "JIS" and European Design Standard 90 N. American Design Standard

Bolt Kit Composition

Stud Bolt ----- 4 Pcs. } 1 Set
Nut ----- 4 Pcs. }

Note: In case of bolt kit model number having "05", four hexagon socket head cap screws only.

Tightening Torque:

12-15 Nm (106-133 IN. lbs.)

Bolt Kits Selection Chart

Model Numbers	Quantity of valves to be stacked			Approx. Mass g (lbs.)
	Solenoid Operated Directional Valve (*-DSG-03)	End Plate (MDC-03)	Modular Valve & Connecting Plate	
MBK-03-01-10*	1	0	1	120(.26)
	0	1		
MBK-03-02-10*	1	0	2	160(.35)
	0	1		
MBK-03-03-10*	1	0	3	200(.44)
	0	1		
MBK-03-04-10*	1	0	4	240(.53)
	0	1		
MBK-03-05-10*	1★	0	0	40(.09)
	0	1		

★ The solenoid operated directional valve comes with mounting bolts.

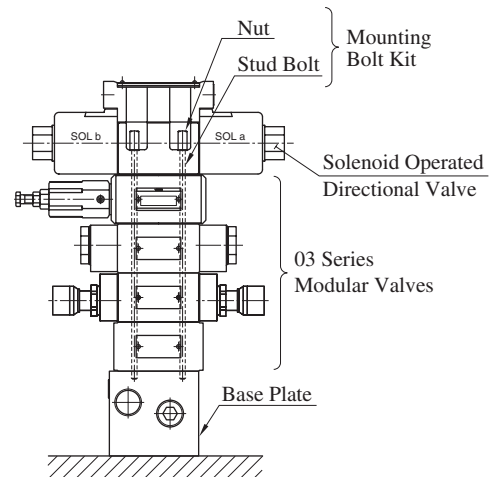

Stacking Example

MBK-03-*-10/1090

Stud Bolt

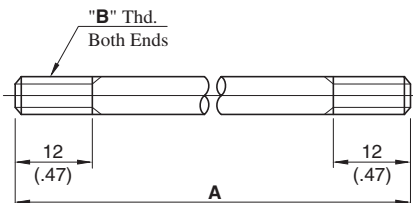

Nut

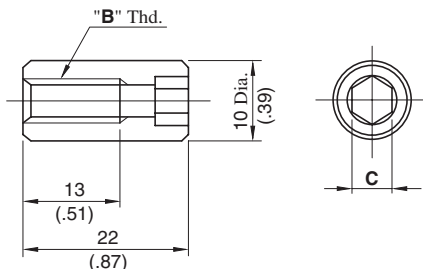

MBK-03-05-10/1090

Socket Head Cap Screw

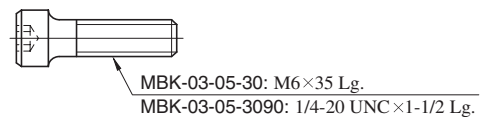

DIMENSIONS IN MILLIMETRES (INCHES)

Model Numbers	A mm (In.)	"B" Thd.	C
MBK-03-01-10	103 (4.06)	M6	5 (.20)
MBK-03-02-10	158 (6.22)		
MBK-03-03-10	213 (8.39)		
MBK-03-04-10	268 (10.55)		
MBK-03-01-1090	103 (4.06)	1/4-20 UNC	4.76 (3/16)
MBK-03-02-1090	158 (6.22)		
MBK-03-03-1090	213 (8.39)		
MBK-03-04-1090	268 (10.55)		

3/4 Modular Valves

Type of Modular Valve

Class	Model Numbers	Graphic Symbols	Page	Class	Model Numbers	Graphic Symbols	Page
Solenoid Controlled Pilot Operated Directional Valve	(S-)DSHG-06-***-*-53/5390		381	Directional Control Valves	Pilot Operated Check Valves (for "A-Line", Internal Pilot-) Internal Drain Type		626
					MPA-06-*-30/3090	Pilot Operated Check Valves (for "A-Line", External Pilot-) External Drain Type	
MPA-06-*-X-30/3090	Pilot Operated Check Valves (for "A-Line", External Pilot-) Internal Drain Type		626				
MPA-06-*-Y-30/3090	Pilot Operated Check Valves (for "B-Line", Internal Pilot-) Internal Drain Type		626				
MPB-06-*-30/3090	Pilot Operated Check Valves (for "B-Line", External Pilot-) External Drain Type		626				
MPB-06-*-X-30/3090	Pilot Operated Check Valves (for "B-Line", External Pilot-) Internal Drain Type		626				
MPB-06-*-Y-30/3090	Pilot Operated Check Valves (for "A&B-Lines", Internal Pilot-) Internal Drain Type		626				
MPW-06-*-30/3090	Mounting Bolts		630		Bolt Kits		
MBK-06-*-30/3090							
Pressure Control Valves	Reducing Valves (for "P-Line")		620		Pressure Control Valves	Reducing Valves (for "A-Line")	
	MRP-06-*-30/3090	Reducing Valves (for "B-Line")		620			
	MRA-06-*-30/3090	MRB-06-*-30/3090	Flow Control Valves	Throttle and Check Valves (for "A-Line", Metre-out)			623
	MSA-06-X-30/3090	Throttle and Check Valves (for "A-Line", Metre-in)			623		
MSA-06-Y-30/3090	Throttle and Check Valves (for "B-Line", Metre-out)			623			
MSB-06-X-30/3090	Throttle and Check Valves (for "B-Line", Metre-in)			623			
MSB-06-Y-30/3090	Throttle and Check Valves (for "A&B-Lines", Metre-out)		623	Throttle and Check Valves (for "A&B-Lines", Metre-in)		623	
MSW-06-X-30/3090	MSW-06-Y-30/3090						

★ Because drain ports "V" and "W" are not provided for solenoid controlled pilot operated directional valves of Pressure Centred Type (3H*) and models with Pilot Piston (P*), those valves cannot be used in combination with modular valves.

Reducing Modular Valves

Specifications

Model Numbers	Max. Operating Pressure MPa(PSI)	Max. Flow* L/min (U.S.GPM)
MR*-06-A-30/3090	25 (3630)	125 (33)
MR*-06-C-30/3090 B H		500 (132)

★ In the pressure adjustment ranges "A" and "B", maximum flow rates are limited by the pressure setting on the secondary side. Referring to the secondary pressure vs. maximum flow characteristics on the following page, use the valve at the maximum flow rate within a zone highlighted with .

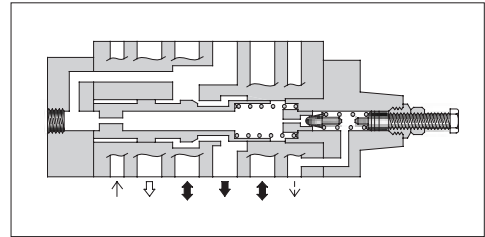

Model Number Designation

F-	MRP	-06	-B	-30	*
Special Seals	Series Number	Valve Size	Pres. Adj. Range MPa (PSI)	Design Number	Design Standard
F: Special Seals for Phosphate Ester Type Fluids (Omit if not required)	MRP: Reducing Valve for P-Line MRA: Reducing Valve for A-Line MRB: Reducing Valve for B-Line	06	A: 0.7-7 (100-1020) B: 1.5-7 (220-1020) C: 3.5-14 (510-2030) H: 7-21 (1020-3050)	30	Refer to ★

★ Design Standards: None Japanese Standard "JIS" and European Design Standard
90 N. American Design Standard

Instructions

- Connect **Drain Line (Y port)** to oil tank independently so as to obtain stable pressure setting. At the same time, the solenoid controlled pilot operated directional valve to be used in combination with this valve must be of internal drain type (with T).
- To make pressure adjustment, loosen the lock nut and turn the pressure adjustment screw clockwise or anti-clockwise. For an increase of pressure, turn the screw clockwise. Be sure to re-tighten the lock nut firmly after making adjustment to the pressure.

Graphic Symbols

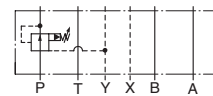

MRP-06

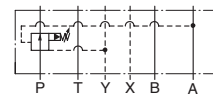

MRA-06

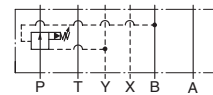

MRB-06

Typical Performance Characteristics

Hydraulic Fluid: Viscosity 35 mm²/s (164 SSU), Specific Gravity 0.850

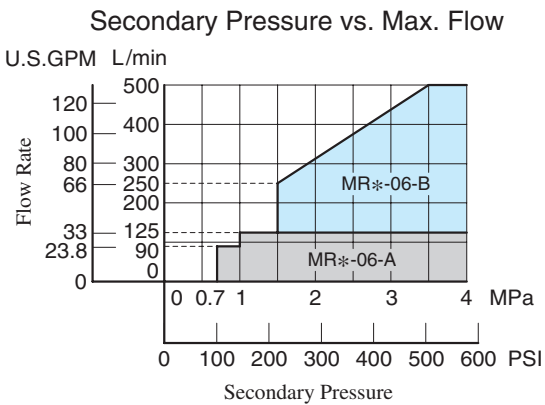
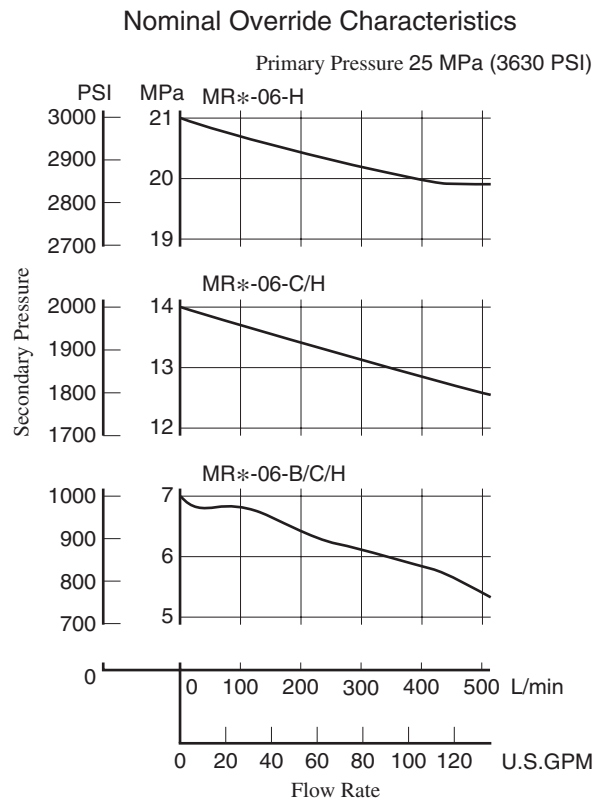
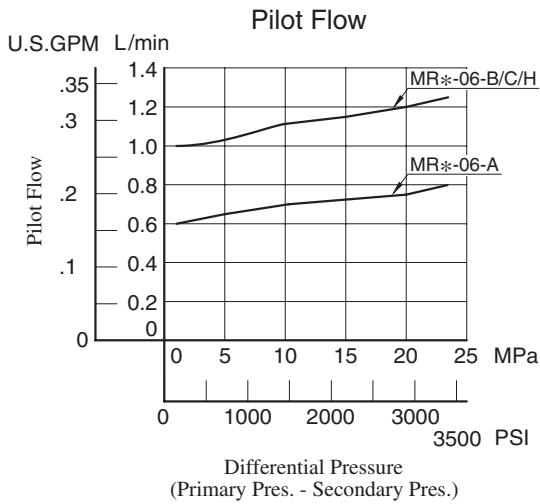
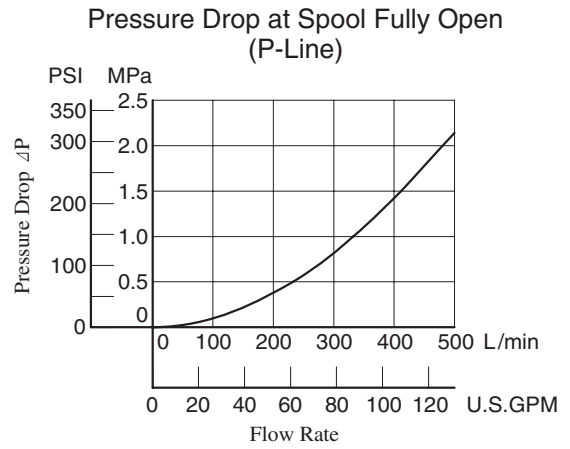
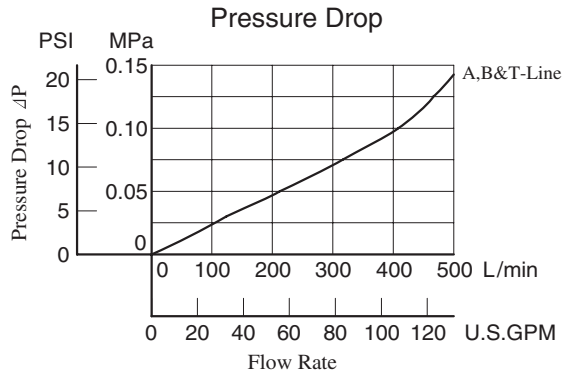

MRP-06-*-30/3090
 MRA-06-*-30/3090
 MRB-06-*-30/3090

**DIMENSIONS IN
 MILLIMETRES (INCHES)**

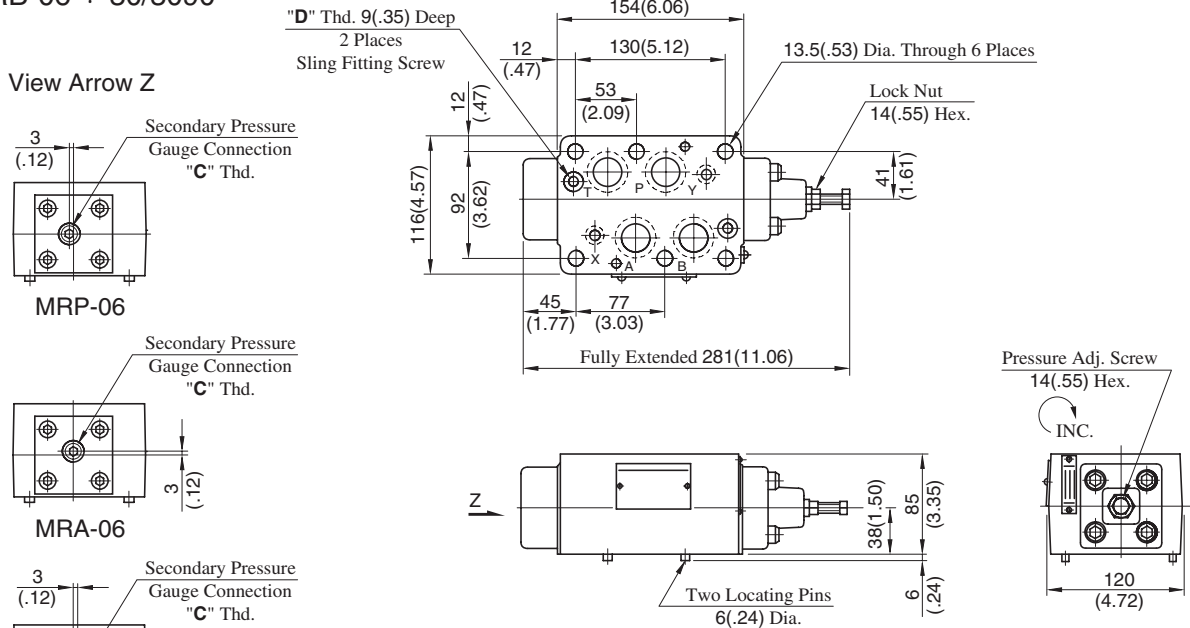

Approx. Mass..... 11.1 kg (24.5 lbs.)

Model Numbers	Thread Size	
	"C" Thd.	"D" Thd.
MR*-06-*-30	Rc 1/4 = 1/4 BSP.Tr	M8
MR*-06-*-3090	1/4 NPT	5/16-18 UNC

■ Spare Parts List

MRP-06-*-30/3090
 MRA-06-*-30/3090
 MRB-06-*-30/3090

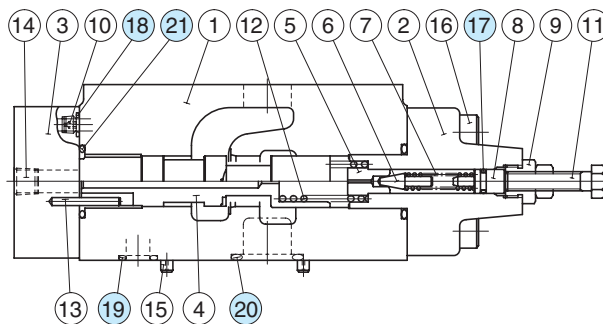

● List of Seals

Item	Name of Parts	Part Numbers	Qty.	Remarks
17	O-Ring	SO-NA-P9	1	Included in Seal Kit Kit No.: KS-MRP-06-10
18	O-Ring	SO-NB-P9	5	
19	O-Ring	SO-NB-P14	2	
20	O-Ring	SO-NB-P28	4	
21	O-Ring	SO-NB-P30	2	

Throttle and Check Modular Valves

Specifications

Model Numbers	Max. Operating Pressure MPa (PSI)	Max. Flow L/min (U.S.GPM)
MSA-06-*-30/3090 MSB-06-*-30/3090 MSW-06-*-30/3090	25 (3630)	500 (132)

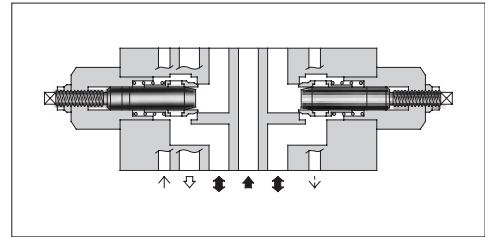

Model Number Designation

F-	MSW	-06	-X	-30	*
Special Seals	Series Number	Valve Size	Direction of Flow	Design Number	Design Standard
F: Special Seals for Phosphate Ester Type Fluids (Omit if not required)	MSA : Throttle and Check Valve for A-Line MSB : Throttle and Check Valve for B-Line MSW : Throttle and Check Valve for A&B-Lines	06	X : Metre-out Y : Metre-in	30	Refer to ★

★ Design Standards: None Japanese Standard "JIS" and European Design Standard 90 N. American Design Standard

Instructions

- To make flow rate adjustment, loosen lock nut and turn the flow adjustment screw clockwise or anti-clockwise. To throttle the flow, turn the screw clockwise. Be sure to re-tighten the lock nut firmly after the adjustment of the flow rate is completed.

Graphic Symbols

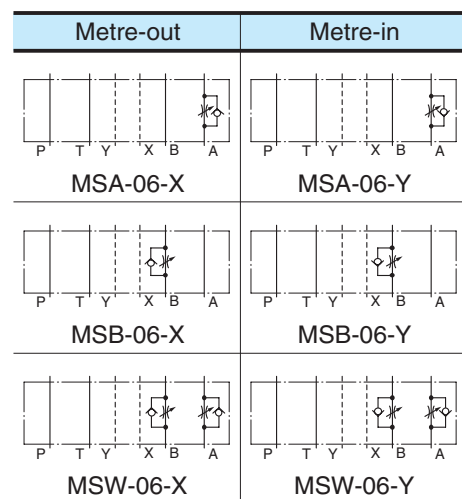

Typical Performance Characteristics

Hydraulic Fluid: Viscosity 35 mm²/s (164 SSU), Specific Gravity 0.850

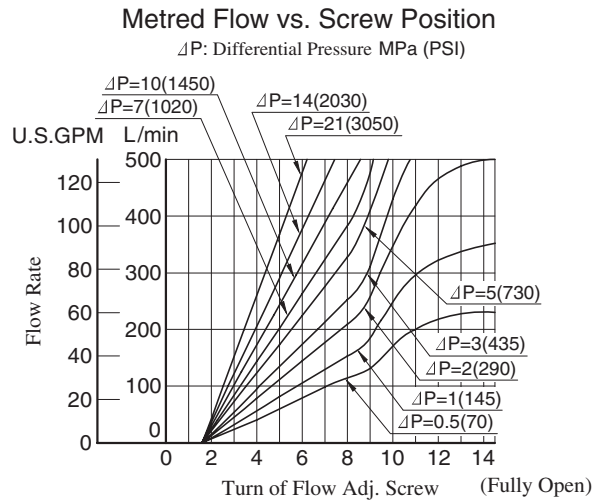
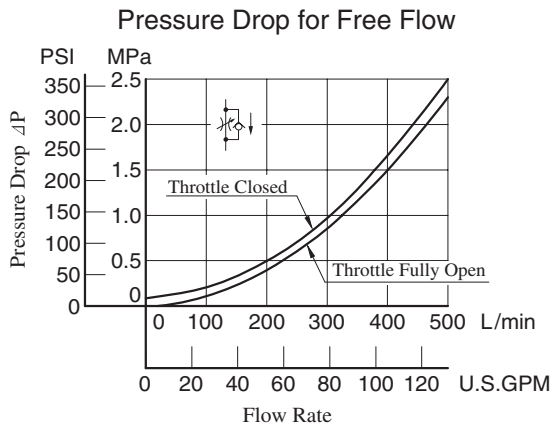
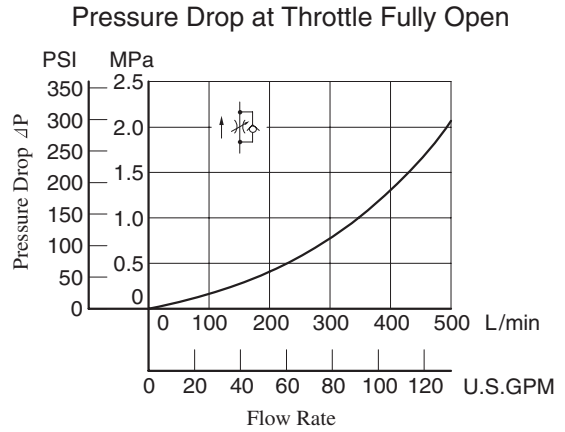
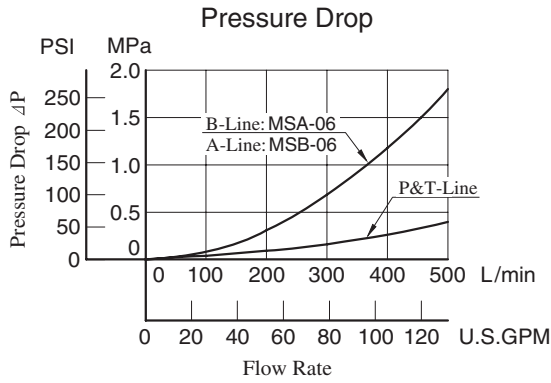

MSW-06-X-30/3090

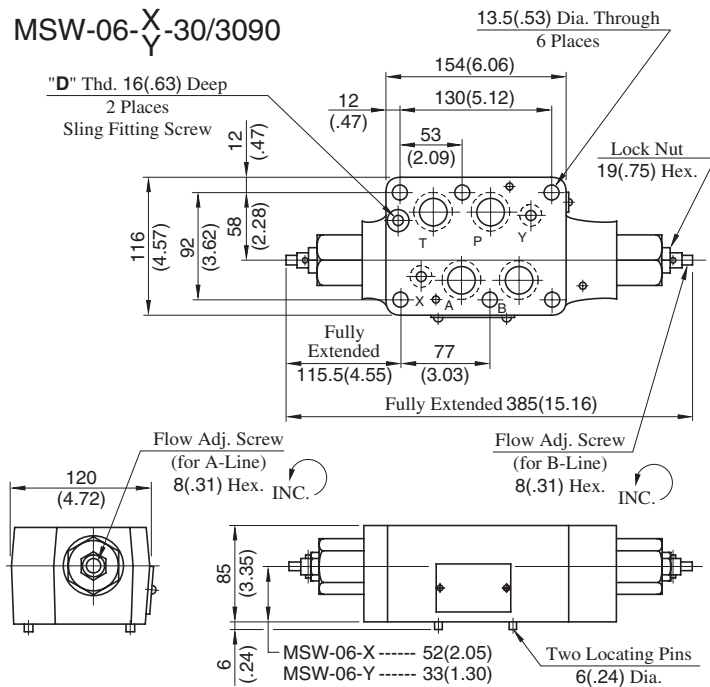

DIMENSIONS IN MILLIMETRES (INCHES)

Model Numbers	"D" Thd.
MS*-06-*-30	M8
MS*-06-*-3090	5/16-18 UNC

Approx. Mass..... 12.2 kg (26.9 lbs.)

MSA-06-X-30/3090

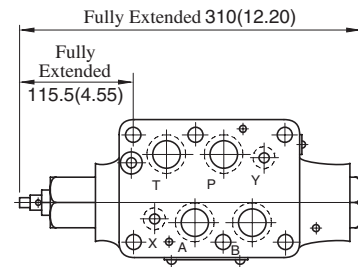

Approx. Mass..... 12 kg (26.5 lbs.)

• For other dimensions, refer to "MSW-06" drawing left.

MSB-06-Y-30/3090

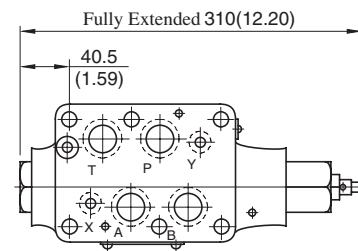

Approx. Mass..... 12 kg (26.5 lbs.)

• For other dimensions, refer to "MSW-06" drawing left.

■ Spare Parts List

MSA-06-*-30/3090

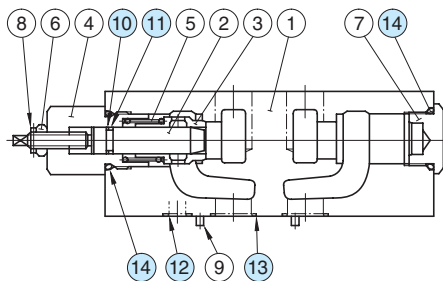

MSB-06-*-30/3090

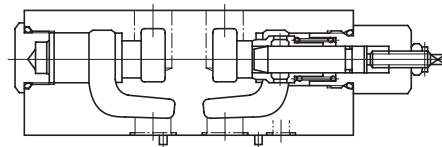

MSW-06-*-30/3090

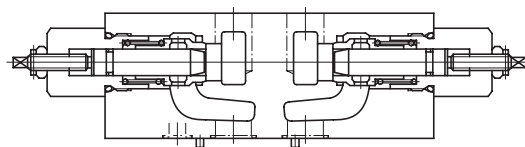

● List of Seals

Item	Name of Parts	Part Numbers	Quantity		
			MSA-06	MSB-06	MSW-06
10	Back Up Ring	SO-BB-P14	1	1	2
11	O-Ring	SO-NA-P14	1	1	2
12	O-Ring	SO-NB-P14	2	2	2
13	O-Ring	SO-NB-P28	4	4	4
14	O-Ring	SO-NB-P32	2	2	2

Note: When ordering seals, please specify the seal kit number from the table right.

● List of Seal Kits

Valve Model Numbers	Seal Kit Numbers
MSA-06	KS-MSA-06-10
MSB-06	
MSW-06	KS-MSW-06-10

Pilot Operated Check Modular Valves

Specifications

Model Numbers	Max. Operating Pressure MPa (PSI)	Max. Flow L/min (U.S.GPM)
MPA-06*-**-30/3090 MPB-06*-**-30/3090 MPW-06*-30/3090	25 (3630)	500 (132)

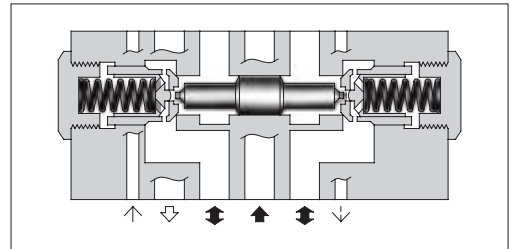

Model Number Designation

F-	MPA	-06	S	-2	-X	-30	*
Special Seals	Series Number	Valve Size	Port Tapping Feature of Pilot-Drain Port ^{★1}	Cracking Pressure MPa (PSI)	Pilot-Drain ^{★2} Connection	Design Number	Design Standard
F: Special Seals for Phosphate Ester Type Fluids (Omit if not required)	MPA : Pilot Operated Check Valve for A-Line MPB : Pilot Operated Check Valve for B-Line MPW : Pilot Operated Check Valve for A&B-Lines	06	None : Taper Thread S : Straight Thread (Applicable only for Japanese Std. "JIS")	2 : 0.2 (29) 4 : 0.4 (58)	None: Internal Pilot-Internal Drain X : External Pilot-External Drain Y : External Pilot-Internal Drain	30	Refer to ^{★3}

★1. This item applies only to External Pilot or External Drain Type.

★2. Only "None: Internal Pilot-Internal Drain Type" is available for MPW (for "A&B-Lines").

★3. Design Standards: None Japanese Standard "JIS" and European Design Standard
90 N. American Design Standard

Graphic Symbols

Pilot-Drain type Model No.	Internal pilot- Internal drain type	Exnternal pilot- External drain type	External pilot- Internal drain type
MPA-06	 MPA-06-*	 MPA-06*-*-X	 MPA-06*-*-Y
MPB-06	 MPB-06-*	 MPB-06*-*-X	 MPB-06*-*-Y
MPW-06	 MPW-06-*	—	—

Typical Performance Characteristics

Hydraulic Fluid: Viscosity 35 mm²/s (164 SSU), Specific Gravity 0.850

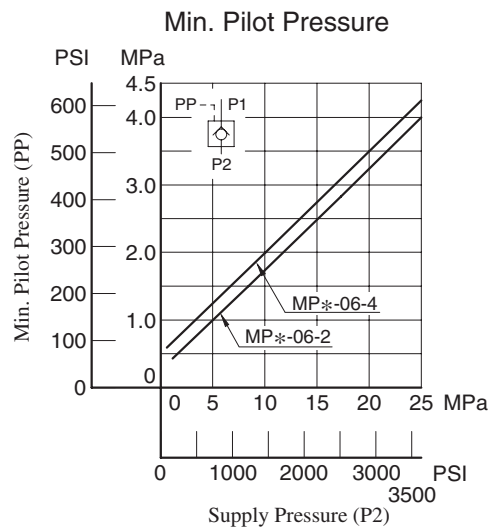
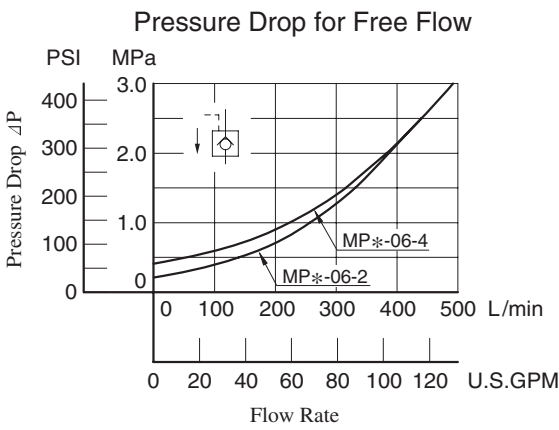
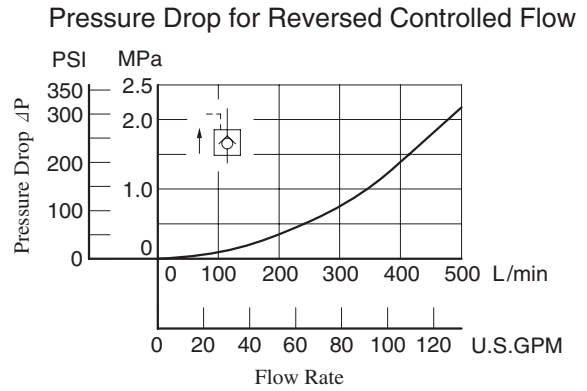
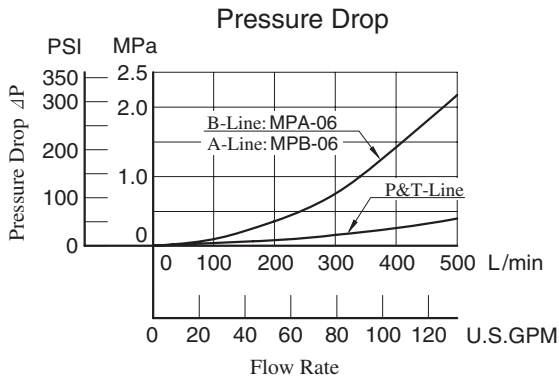

MPA-06-*-30/3090 (Internal Pilot-Internal Drain Type)
 MPB-06-*-30/3090 (Internal Drain Type)
 MPW-06-*-30/3090

DIMENSIONS IN MILLIMETRES (INCHES)

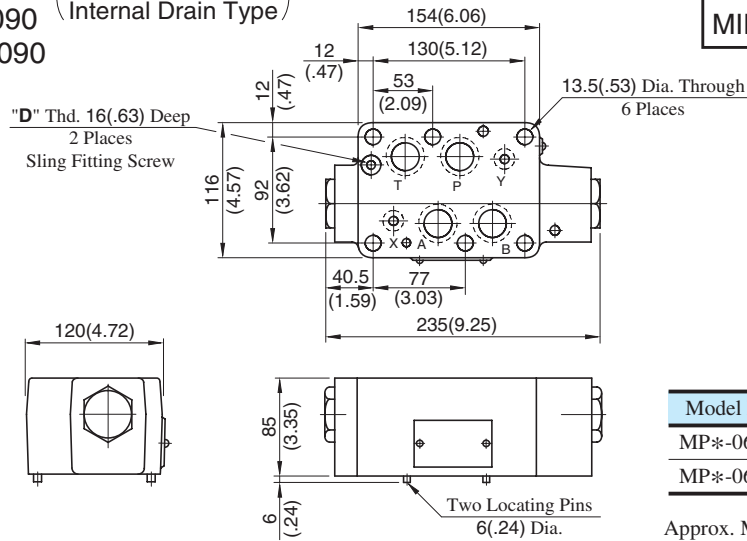

Model Numbers	"D" Thd.
MP*-06-*-30	M8
MP*-06-*-3090	5/16-18 UNC

Approx. Mass..... 11.6 kg (25.6 lbs.)

MPA-06-*-X-30/3090 (External Pilot-External Drain Type)

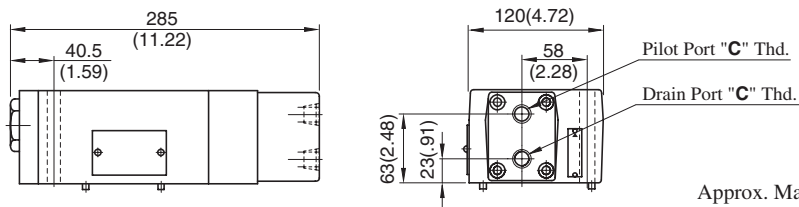

Approx. Mass..... 13 kg (28.7 lbs.)

Model Numbers	Thread Size "C" Thd.
MPA-06-*-X-30	Rc 3/8 = 3/8 BSP. Tr
MPA-06-*-X-3090	3/8 NPT
MPA-06S-*-X-30	G 3/8

Approx. Mass..... 11.6 kg (25.6 lbs.)

• For other dimensions, refer to "Internal pilot-Internal drain type" drawing above.

MPB-06-*-X-30/3090 (External Pilot-External Drain Type)

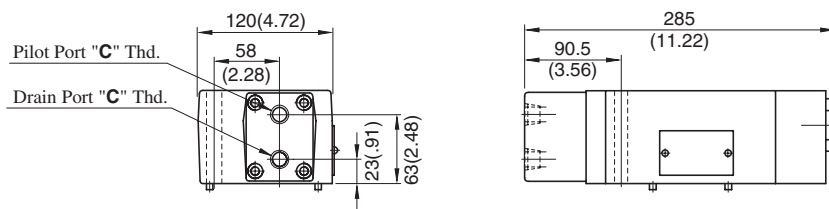

Approx. Mass..... 13 kg (28.7 lbs.)

Model Numbers	Thread Size "C" Thd.
MPB-06-*-X-30	Rc 3/8 = 3/8 BSP. Tr
MPB-06-*-X-3090	3/8 NPT
MPB-06S-*-X-30	G 3/8

Approx. Mass..... 11.6 kg (25.6 lbs.)

• For other dimensions, refer to "Internal pilot-Internal drain type" drawing above.

MPB-06-*-Y-30/3090 (External Pilot-Internal Drain Type)

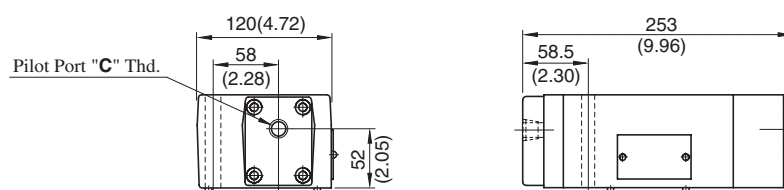

Approx. Mass..... 11.6 kg (25.6 lbs.)

• For other dimensions, refer to "Internal pilot-Internal drain type" drawing above.

Spare Parts List

Internal Pilot- Internal Drain Type

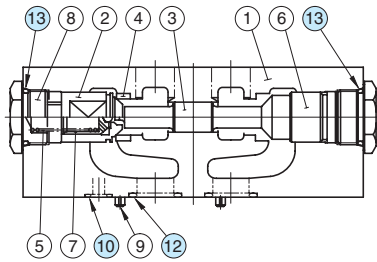

MPA-06-*-30/3090

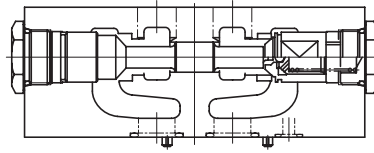

MPB-06-*-30/3090

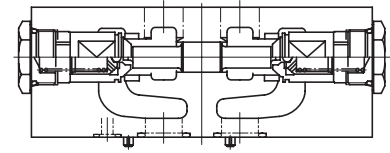

MPW-06-*-30/3090

External Pilot- External Drain Type

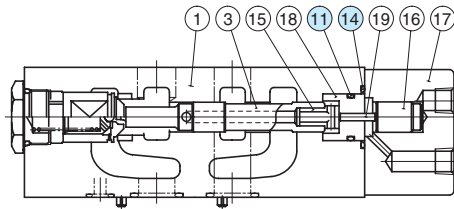

MPA-06*-*-X-30/3090

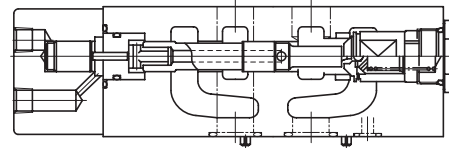

MPB-06*-*-X-30/3090

External Pilot- Internal Drain Type

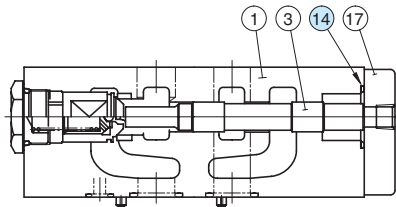

MPA-06*-*-Y-30/3090

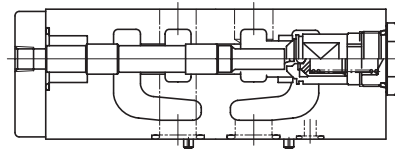

MPB-06*-*-Y-30/3090

List of Seals

Item	Name of Parts	Part Numbers	Quantity		
			Internal Pilot- Internal Drain	External Pilot- External Drain	External Pilot- Internal Drain
10	O-Ring	SO-NB-P14	2	2	2
11	O-Ring	SO-NA-P26	—	1	—
12	O-Ring	SO-NB-P28	4	4	4
13	O-Ring	SO-NB-P32	2	1	1
14	O-Ring	SO-NB-P36	—	1	1

Note: When ordering seals, please specify the seal kit number from the table right.

List of Seal Kits

Valve Model Numbers	Seal Kit Numbers
MPA-06-*	KS-MPA-06-10
MPB-06-*	
MPW-06-*	
MPA-06*-*-X	KS-MPA-06-X-10
MPB-06*-*-X	
MPA-06*-*-Y	KS-MPA-06-Y-10
MPB-06*-*-Y	

Mounting Bolt Kits For Modular Valves

Valves are mounted with six stud bolts. Valve combination varies according to the circuit type. Hence, the mounting bolt kits are available on a combination type basis. When ordering the mounting bolt kit, be sure to give the bolt kit model number from the table below.



Model Number Designation

MBK	-06	-04	-30	*
Series Number	Size of Modular Valve	Bolt Number	Design Number	Design Standard
MBK: Mounting Bolt Kits for Modular Valves	06	01, 02, 03, 04	30	None: Japanese Standard "JIS" and European Design Standard 90: N.American Design Standard

Bolt Kits Selection Chart

Bolt Kit Model Numbers	Quantity of Valves to be Stacked		Approx. Mass kg (lbs.)
	Sol. Cont. Pilot Operated Directional Valves (*-DSHG-06)	Modular Valve	
MBK-06-01-30*	1	1	1.1(2.4)
MBK-06-02-30*	1	2	1.5(3.3)
MBK-06-03-30*	1	3	2.0(4.4)
MBK-06-04-30*	1	4	2.4(5.3)

Bolt Kit Composition

Stud Bolt ----- 6 Pcs. } 1 Set
 Nut ----- 6 Pcs. }

Tightening Torque:

50-60 Nm (443-531 in. lbs.)

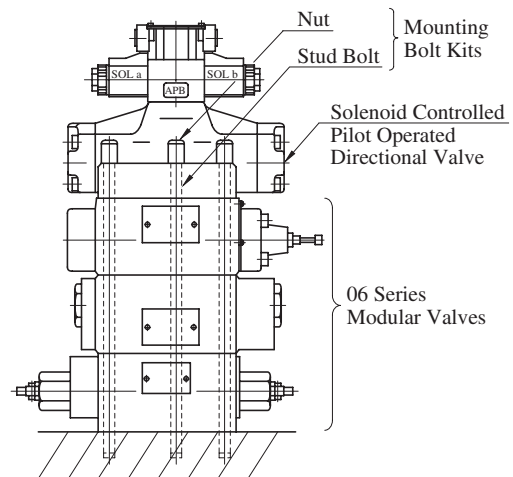

Stacking Example

MBK-06-*-30/3090

DIMENSIONS IN MILLIMETRES (INCHES)

Stud Bolt

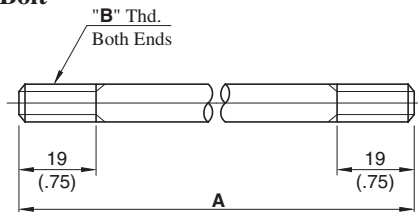

Nut

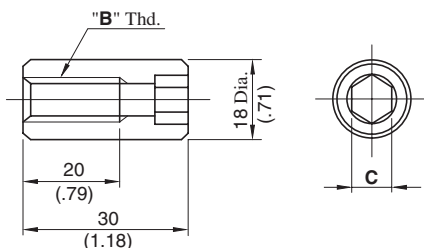

Model Numbers	A mm (in.)
MBK-06-01	161 (6.34)
MBK-06-02	246 (9.69)
MBK-06-03	331 (13.03)
MBK-06-04	416 (16.38)

Model Numbers	"B" Thd.	C
MBK-06-*-30	M12	10 (.39)
MBK-06-*-3090	1/2-13 UNC	9.5 (3/8)

■ Mounting Surface Dimensions for 3/4 Modular Valve

When mounting 06 series modular valve, be sure to use a sub-plate for 3/4 solenoid controlled pilot operated directional valves.

Name	Sub-plate Model Number	Page
Sub-plate for 3/4 Solenoid Controlled Pilot Operated Directional Valves	DHGM-06*-50/5080/5090	402

Also, when no sub-plates are used, be sure to use the following mounting surface.

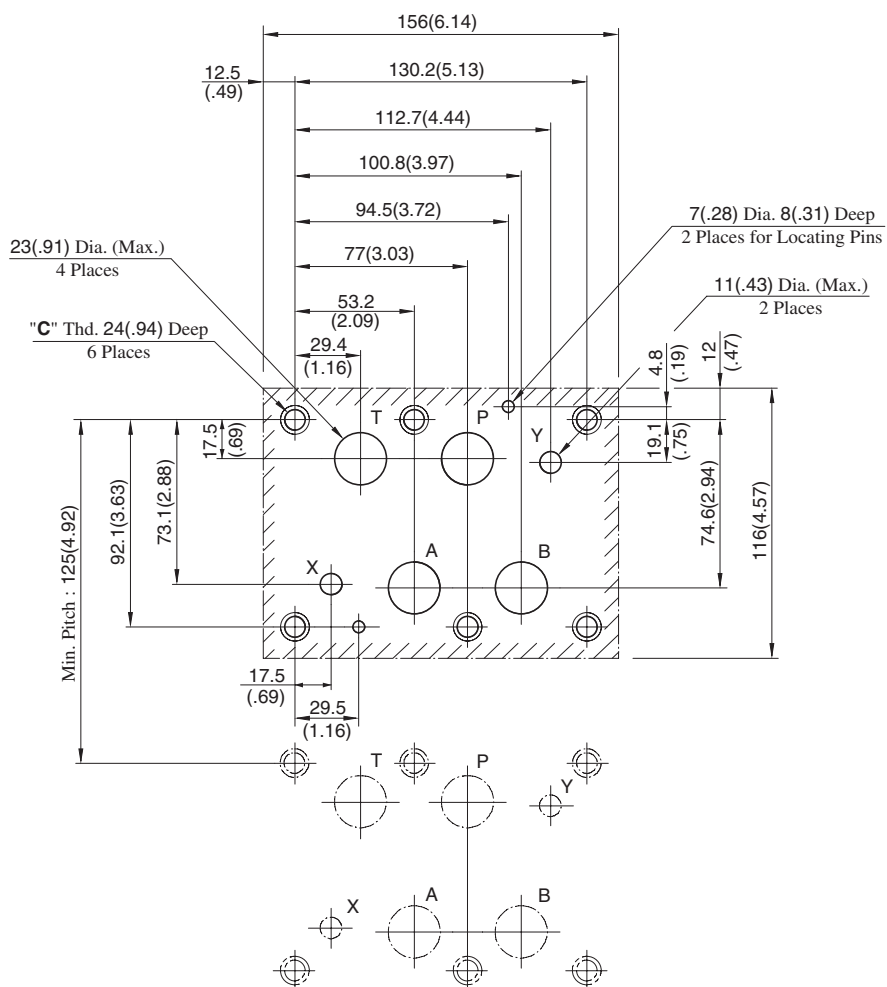

Design Std.	"C" Thd.
Japanese std. "JIS" and European Design Std.	M12
N. American Design Std.	1/2-13 UNC

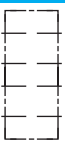

Type of Modular Valve

Class	Model Numbers	Graphic Symbols	Page	Class	Model Numbers	Graphic Symbols	Page
	Solenoid Controlled Pilot Operated Directional Valve (S-)DSHG-10-***-**-43/4390		381		Pilot Operated Check Valves (for "A-Line", Internal Pilot-) Internal Drain Type MPA-10-*-30/3090		640
Pressure Control Valves	Reducing Valves (for "P-Line") MRP-10-*-30/3090		634		Pilot Operated Check Valves (for "A-Line", External Pilot-) External Drain Type MPA-10-*-X-30/3090		640
	Reducing Valves (for "A-Line") MRA-10-*-30/3090		634		Pilot Operated Check Valves (for "A-Line", External Pilot-) Internal Drain Type MPA-10-*-Y-30/3090		640
	Reducing Valves (for "B-Line") MRB-10-*-30/3090		634		Pilot Operated Check Valves (for "B-Line", Internal Pilot-) Internal Drain Type MPB-10-*-30/3090		640
Flow Control Valves	Throttle and Check Valves (for "A-Line", Metre-out) MSA-10-X-30/3090		637		Pilot Operated Check Valves (for "B-Line", External Pilot-) External Drain Type MPB-10-*-X-30/3090		640
	Throttle and Check Valves (for "A-Line", Metre-in) MSA-10-Y-30/3090		637		Pilot Operated Check Valves (for "B-Line", External Pilot-) Internal Drain Type MPB-10-*-Y-30/3090		640
	Throttle and Check Valves (for "B-Line", Metre-out) MSB-10-X-30/3090		637		Pilot Operated Check Valves (for "A&B-Lines", Internal Pilot-) Internal Drain Type MPW-10-*-30/3090		640
	Throttle and Check Valves (for "B-Line", Metre-in) MSB-10-Y-30/3090		637	Mounting Bolts	Bolt Kits MBK-10-*-10/1090		644
	Throttle and Check Valves (for "A&B-Lines", Metre-out) MSW-10-X-30/3090		637				
	Throttle and Check Valves (for "A&B-Lines", Metre-in) MSW-10-Y-30/3090		637				

★ Because drain ports "V" and "W" are not provided for solenoid controlled pilot operated directional valves of Pressure Centred Type (3H*) and models with Pilot Piston (P*), those valves cannot be used in combination with modular valves.

Reducing Modular Valves

Specifications

Model Numbers	Max. Operating Pressure MPa(PSI)	Max. Flow* L/min (U.S.GPM)
MR*-10-A-30/3090	25 (3630)	250 (66)
B MR*-10-C-30/3090		800 (211)
H		

★ In the pressure adjustment ranges "A" and "B", maximum flow rates are limited by the pressure setting on the secondary side. Referring to the secondary pressure vs. maximum flow characteristics on the following page, use the valve at the maximum flow rate within a zone highlighted with .

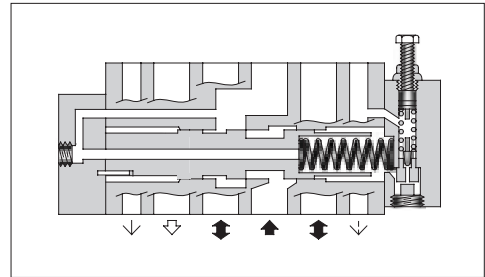

Model Number Designation

F-	MRP	-10	-B	-30	*
Special Seals	Series Number	Valve Size	Pres. Adj. Range MPa (PSI)	Design Number	Design Standard
F: Special Seals for Phosphate Ester Type Fluids (Omit if not required)	MRP: Reducing Valve for P-Line MRA: Reducing Valve for A-Line MRB: Reducing Valve for B-Line	10	A: 0.7-7 (100-1020) B: 1.5-7 (220-1020) C: 3.5-14 (510-2030) H: 7-21 (1020-3050)	30	Refer to ★

★ Design Standards: None Japanese Standard "JIS" and European Design Standard
90 N. American Design Standard

Instructions

- Connect **Drain Line (Y port)** to oil tank independently so as to obtain stable pressure setting. At the same time, the solenoid controlled pilot operated directional valve to be used in combination with this valve must be of internal drain type (with T).
- To make pressure adjustment, loosen the lock nut and turn the pressure adjustment screw clockwise or anti-clockwise. For an increase of pressure, turn the screw clockwise. Be sure to re-tighten the lock nut firmly after making adjustment to the pressure.

Graphic Symbols

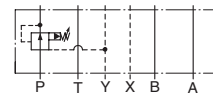

MRP-10

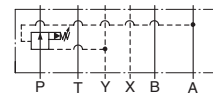

MRA-10

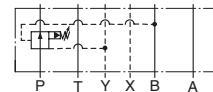

MRB-10

Typical Performance Characteristics

Hydraulic Fluid: Viscosity 35 mm²/s (164 SSU), Specific Gravity 0.850

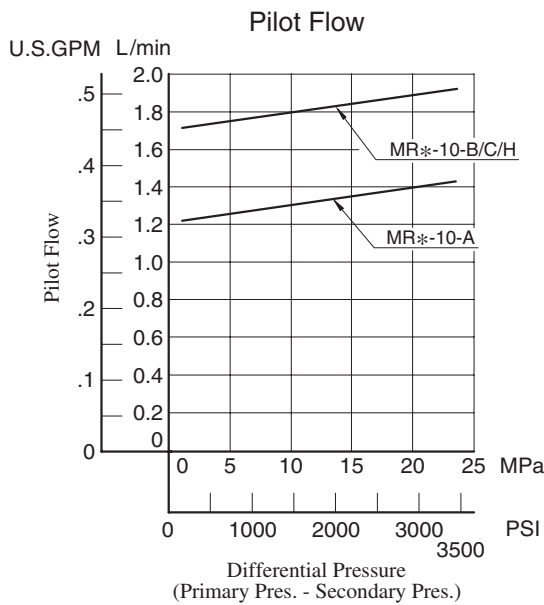
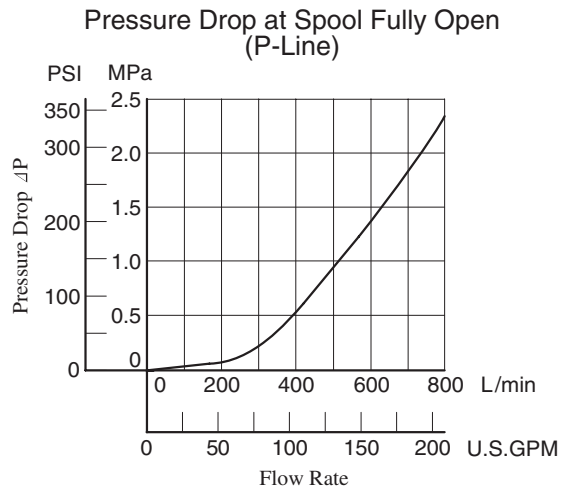
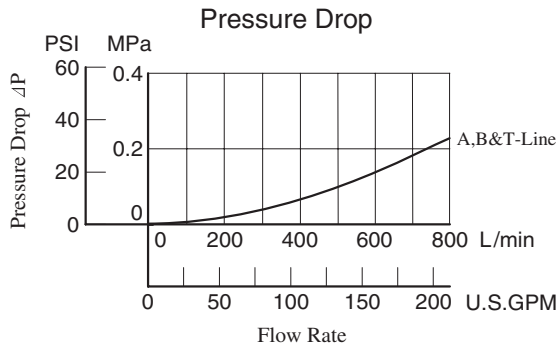

Nominal Override Characteristics

Primary Pressure 25 MPa (3630 PSI)

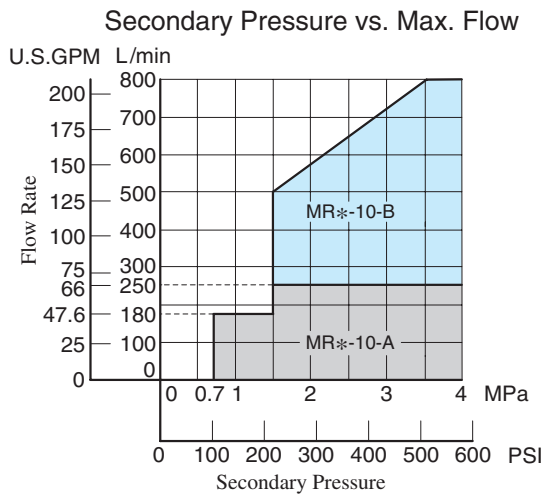
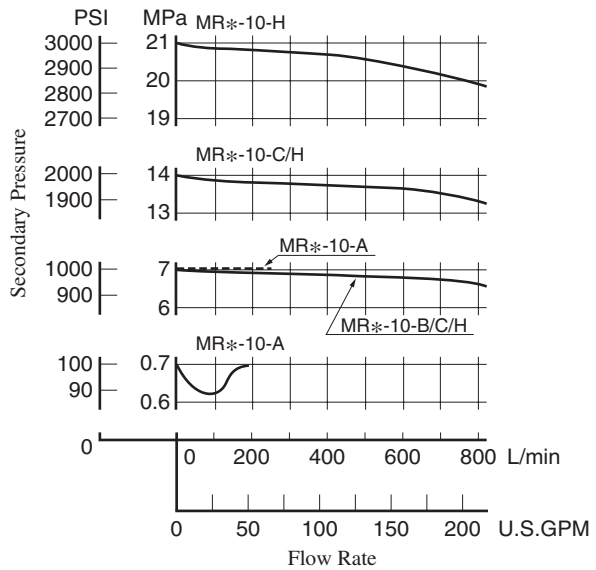

MRP-10-*-30/3090
 MRA-10-*-30/3090
 MRB-10-*-30/3090

**DIMENSIONS IN
 MILLIMETRES (INCHES)**

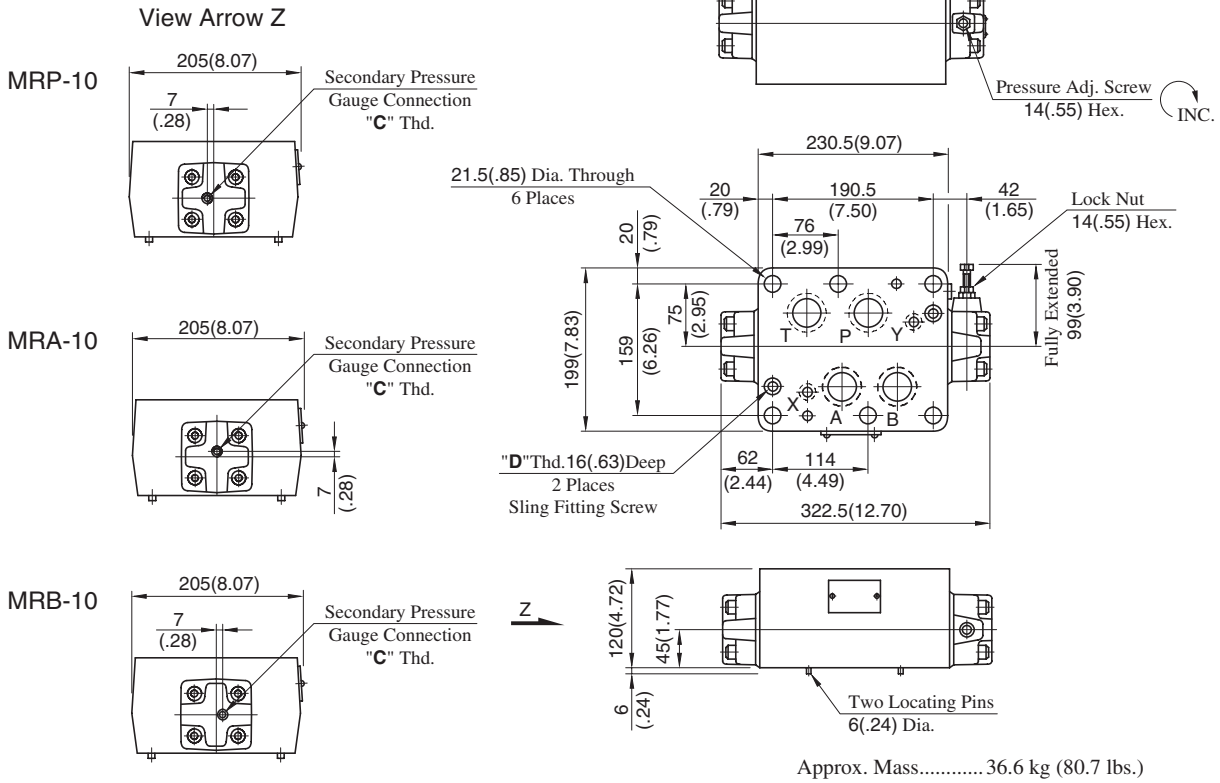

Model Numbers	Thread Size	
	"C" Thd.	"D" Thd.
MR*-10-*-30	Rc 1/4 = 1/4 BSP.Tr	M8
MR*-10-*-3090	1/4 NPT	5/16-18 UNC

■ Spare Parts List

MRP-10-*-30/3090
 MRA-10-*-30/3090
 MRB-10-*-30/3090

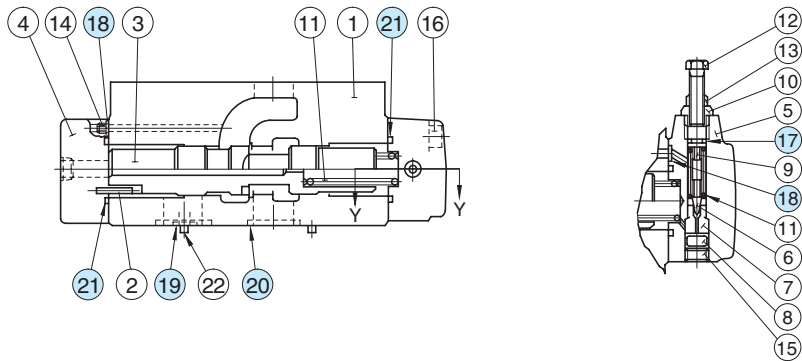

● List of Seals

Item	Name of Parts	Part Numbers	Qty.	Remarks
17	O-Ring	SO-NA-P9	1	Included in Seal Kit Kit No.: KS-MRP-10-10
18	O-Ring	SO-NB-P9	4	
19	O-Ring	SO-NB-P16	2	
20	O-Ring	SO-NB-P40	4	
21	O-Ring	SO-NB-P44	2	

Section Y-Y

Throttle and Check Modular Valves

Specifications

Model Numbers	Max. Operating Pressure MPa (PSI)	Max. Flow L/min (U.S.GPM)
MSA-10-*-30/3090 MSB-10-*-30/3090 MSW-10-*-30/3090	25 (3630)	800 (211)

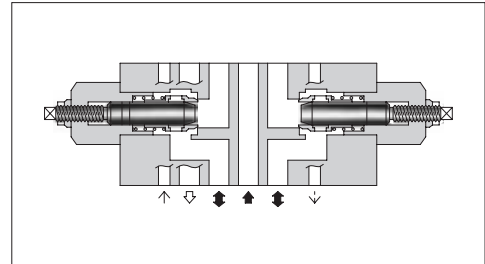

Model Number Designation

F-	MSW	-10	-X	-30	*
Special Seals	Series Number	Valve Size	Direction of Flow	Design Number	Design Standard
F: Special Seals for Phosphate Ester Type Fluids (Omit if not required)	MSA : Throttle and Check Valves for A-Line MSB : Throttle and Check Valves for B-Line MSW : Throttle and Check Valves for A&B-Lines	10	X : Metre-out Y : Metre-in	30	Refer to ★

★ Design Standards: None Japanese Standard "JIS" and European Design Standard 90 N. American Design Standard

Instructions

- To make flow rate adjustment, loosen the lock nut and turn the flow adjustment screw clockwise or anti-clockwise. To throttle the flow, turn the screw clockwise. Be sure to re-tighten the lock nut firmly after the adjustment of the flow rate is completed.

Graphic Symbols

Metre-out	Metre-in
<p>MSA-10-X</p>	<p>MSA-10-Y</p>
<p>MSB-10-X</p>	<p>MSB-10-Y</p>
<p>MSW-10-X</p>	<p>MSW-10-Y</p>

Typical Performance Characteristics

Hydraulic Fluid: Viscosity 35 mm²/s (164 SSU), Specific Gravity 0.850

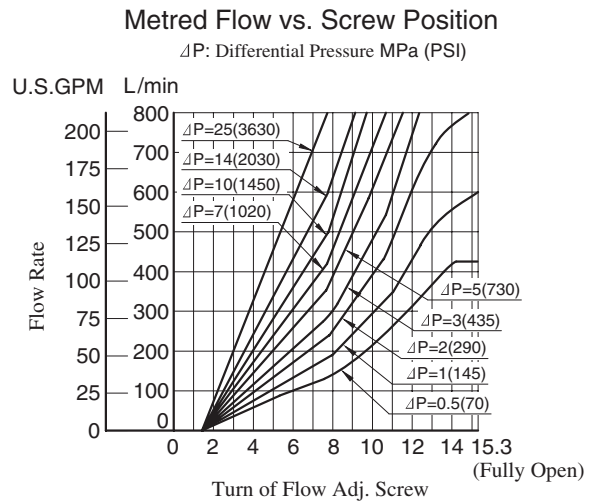
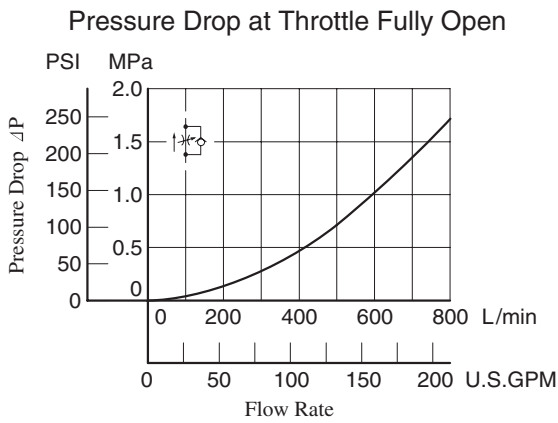
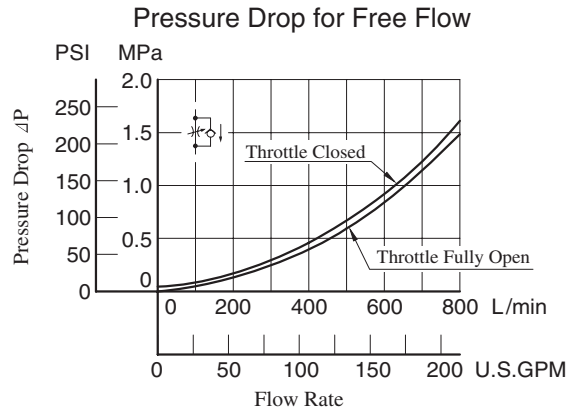
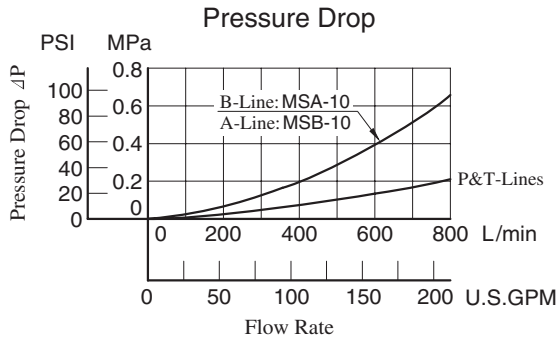

MSW-10-X-Y-30/3090

DIMENSIONS IN MILLIMETRES (INCHES)

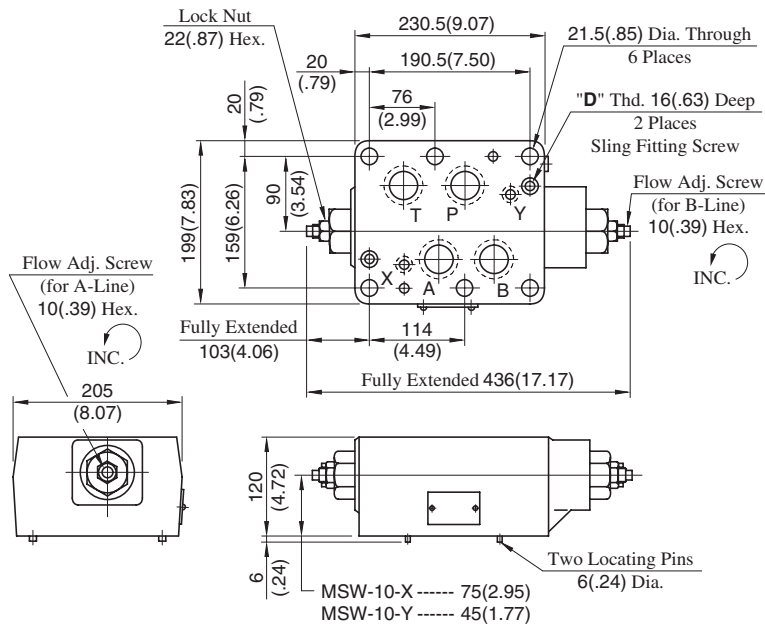

Model Numbers	"D" Thd.
MS*-10-*-30	M8
MS*-10-*-3090	5/16-18 UNC

Approx. Mass..... 35.7 kg (78.7 lbs.)

MSA-10-X-Y-30/3090

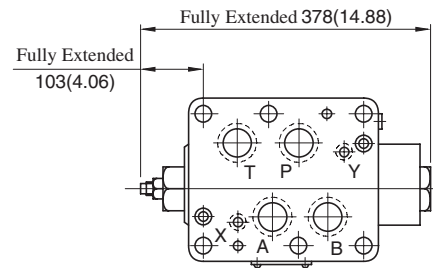

Approx. Mass..... 35 kg (77.2 lbs.)

• For other dimensions, refer to "MSW-10" drawing left.

MSB-10-X-Y-30/3090

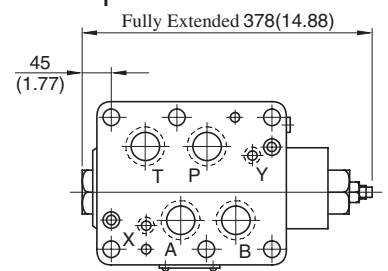

Approx. Mass..... 35 kg (77.2 lbs.)

• For other dimensions, refer to "MSW-10" drawing left.

Spare Parts List

MSA-10-*-30/3090

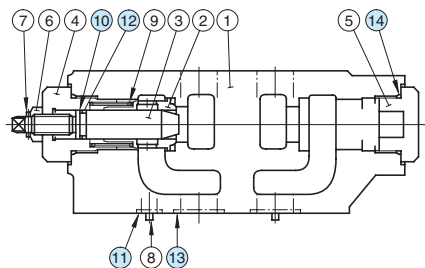

MSB-10-*-30/3090

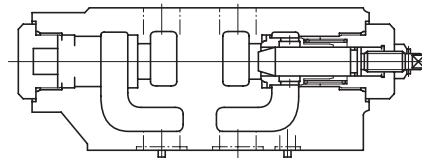

MSW-10-*-30/3090

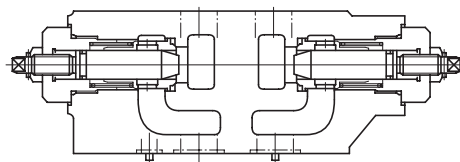

List of Seals

Item	Name of Parts	Part Numbers	Quantity		
			MSA-10	MSB-10	MSW-10
10	Back Up Ring	SO-BB-P20	1	1	2
11	O-Ring	SO-NB-P16	2	2	2
12	O-Ring	SO-NA-P20	1	1	2
13	O-Ring	SO-NB-P40	4	4	4
14	O-Ring	SO-NB-P44	2	2	2

Note: When ordering seals, please specify the seal kit number from the table right.

List of Seal Kits

Valve Model Numbers	Seal Kit Numbers
MSA-10	KS-MSA-10-10
MSB-10	
MSW-10	KS-MSW-10-10

Pilot Operated Check Modular Valves

Specifications

Model Numbers	Max. Operating Pressure MPa (PSI)	Max. Flow L/min (U.S.GPM)
MPA-10*-**-30/3090 MPB-10*-**-30/3090 MPW-10*-**-30/3090	25 (3630)	800 (211)

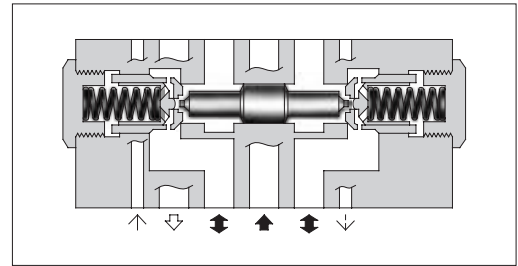

Model Number Designation

F-	MPA	-10	S	-2	-X	-30	*
Special Seals	Series Number	Valve Size	Port Tapping Feature of Pilot-Drain Port ^{★1}	Cracking Pressure MPa (PSI)	Pilot-Drain ^{★2} Connection	Design Number	Design Standard
F: Special Seals for Phosphate Ester Type Fluids (Omit if not required)	MPA : Pilot Operated Check Valve for A-Line MPB : Pilot Operated Check Valve for B-Line MPW : Pilot Operated Check Valve for A&B-Lines	10	None : Taper Thread S : Straight Thread (Applicable only for Japanese Std. "JIS")	2 : 0.2 (29) 4 : 0.4 (58)	None: Internal Pilot-Internal Drain X : External Pilot-External Drain Y : External Pilot-Internal Drain	30	Refer to ^{★3}

★1. This item applies only to External Pilot or External Drain Type.

★2. Only "None: Internal Pilot-Internal Drain Type" is available for MPW (for "A&B-Lines").

★3. Design Standards: None Japanese Standard "JIS" and European Design Standard 90 N. American Design Standard

Graphic Symbols

Pilot-Drain type Model No.	Internal Pilot-Internal Drain Type	External Pilot-External Drain Type	External Pilot-Internal Drain Type
MPA-10	 MPA-10-*	 MPA-10*-*-X	 MPA-10*-*-Y
MPB-10	 MPB-10-*	 MPB-10*-*-X	 MPB-10*-*-Y
MPW-10	 MPW-10-*	—	—

Typical Performance Characteristics

Hydraulic Fluid: Viscosity 35 mm²/s (164 SSU), Specific Gravity 0.850

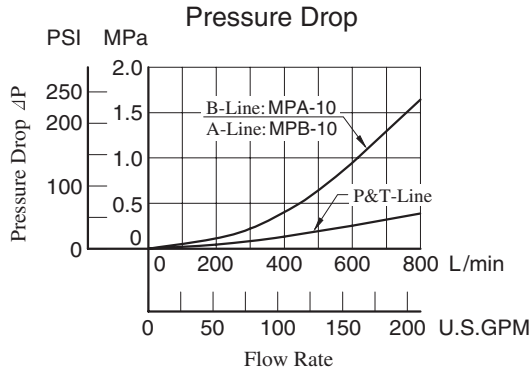

Pressure Drop for Reversed Controlled Flow

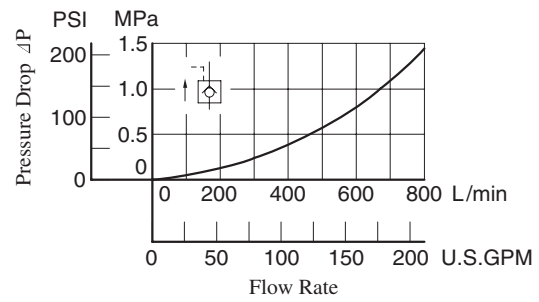

Pressure Drop for Free Flow

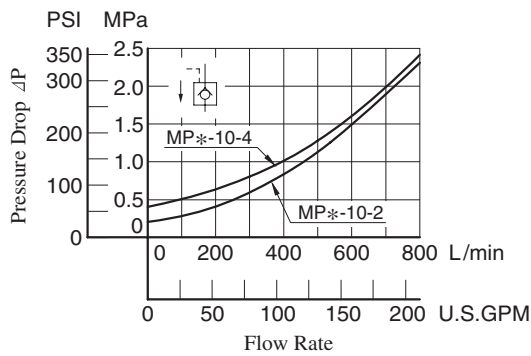

Min. Pilot Pressure

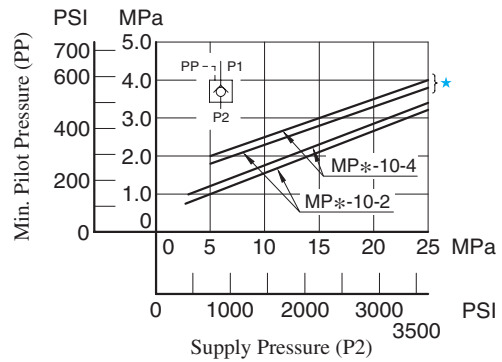

★ In case of 500 L/min (132 U.S.GPM) or more.

MPA-10-*-30/3090 (Internal Pilot-
MPB-10-*-30/3090 Internal Drain Type)
MPW-10-*-30/3090

**DIMENSIONS IN
MILLIMETRES (INCHES)**

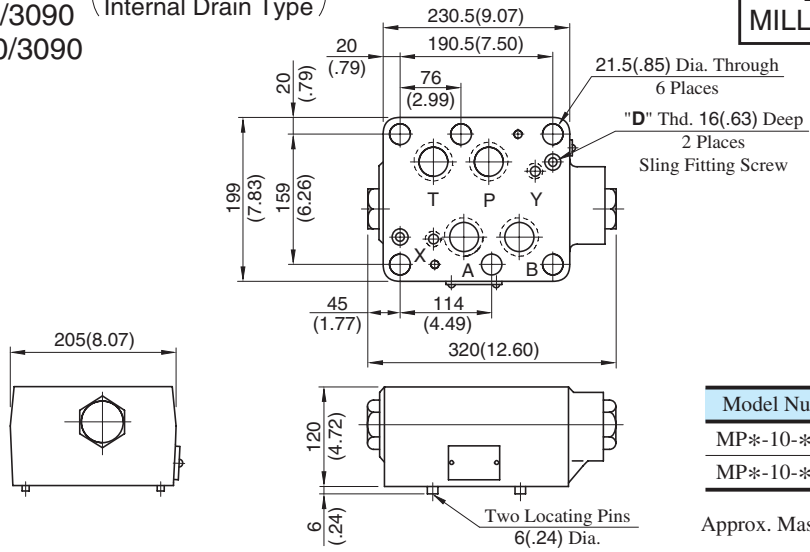

Model Numbers	"D" Thd.
MP*-10-*-30	M8
MP*-10-*-3090	5/16-18 UNC

Approx. Mass.....36.5 kg (80.5 lbs.)

MPA-10-*-X-30/3090 (External Pilot-
External Drain Type)

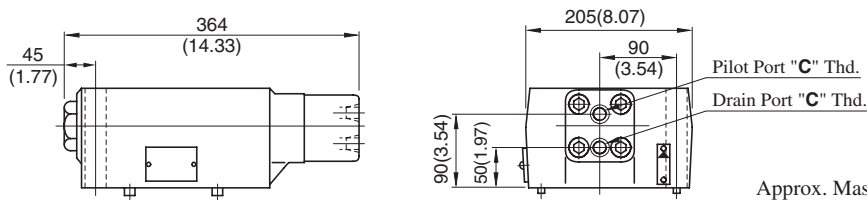

Approx. Mass.....38 kg (83.8 lbs.)

Model Numbers	Thread Size "C" Thd.
MPA-10-*-X-30	Rc 3/8 = 3/8 BSP. Tr
MPA-10-*-X-3090	3/8 NPT
MPA-10S-*-X-30	G 3/8

Approx. Mass.....36.5 kg (80.5 lbs.)

MPA-10-*-Y-30/3090 (External Pilot-
Internal Drain Type)

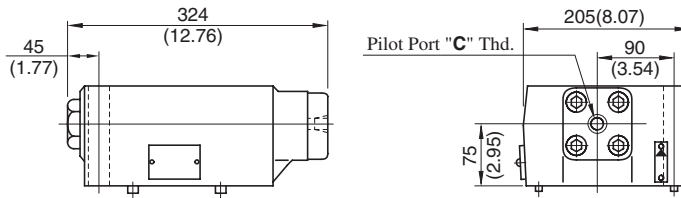

• For other dimensions, refer to "Internal pilot-Internal drain type" drawing above.

MPB-10-*-X-30/3090 (External Pilot-
External Drain Type)

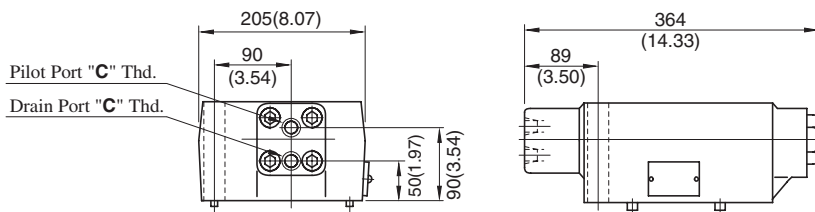

Approx. Mass.....38 kg (83.8 lbs.)

Model Numbers	Thread Size "C" Thd.
MPB-10-*-X-30	Rc 3/8 = 3/8 BSP. Tr
MPB-10-*-X-3090	3/8 NPT
MPB-10S-*-X-30	G 3/8

Approx. Mass.....36.5 kg (80.5 lbs.)

MPB-10-*-Y-30/3090 (External Pilot-
Internal Drain Type)

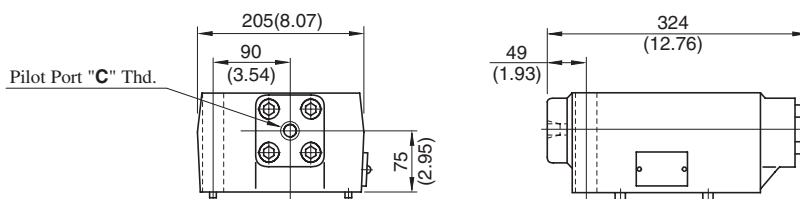

• For other dimensions, refer to "Internal pilot-Internal drain type" drawing above.

Spare Parts List

Internal Pilot- Internal Drain Type

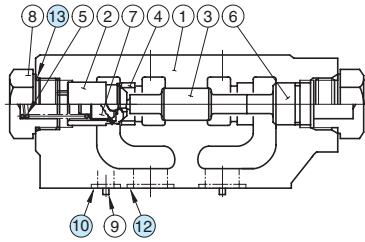

MPA-10*-30/3090

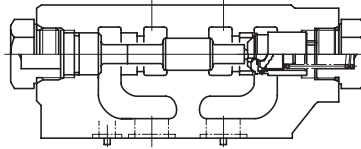

MPB-10*-30/3090

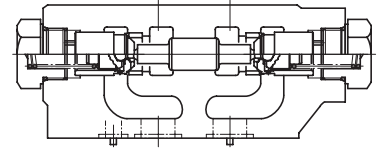

MPW-10*-30/3090

External Pilot- External Drain Type

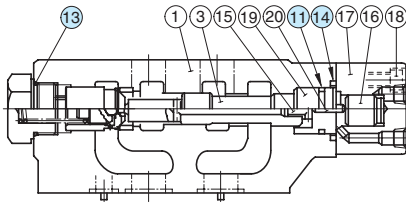

MPA-10*-X-30/3090

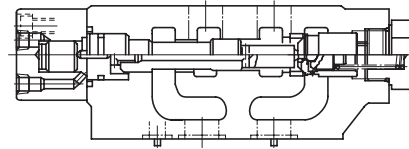

MPB-10*-X-30/3090

External Pilot- Internal Drain Type

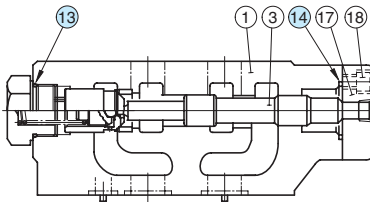

MPA-10*-Y-30/3090

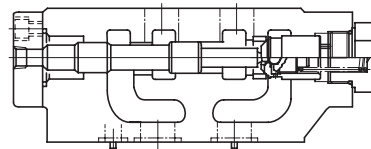

MPB-10*-Y-30/3090

List of Seals

Item	Name of Parts	Part Numbers	Quantity		
			Internal Pilot- Internal Drain	External Pilot- External Drain	External Pilot- Internal Drain
10	O-Ring	SO-NB-P16	2	2	2
11	O-Ring	SO-NB-P34	—	1	—
12	O-Ring	SO-NB-P40	4	4	4
13	O-Ring	SO-NB-P44	2	1	1
14	O-Ring	SO-NB-P46	—	1	1

Note: When ordering seals, please specify the seal kit number from the table right.

List of Seal Kits

Valve Model Numbers	Seal Kit Numbers	
MPA-10*- MPB-10*- MPW-10*-	KS-MPA-10-10	
MPA-10*-X- MPB-10*-X-		KS-MPA-10-X-10
MPA-10*-Y- MPB-10*-Y-		KS-MPA-10-Y-10

Mounting Bolt Kits For Modular Valves

Valves are mounted with six stud bolts. Valve combination varies according to the circuit type. Hence, the mounting bolt kits are available on a combination type basis. When ordering the mounting bolt kit, be sure to give the bolt kit model number from the table below.

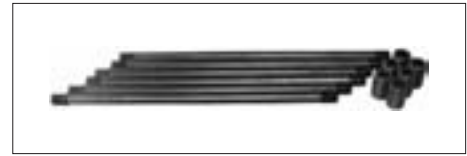

Model Number Designation

MBK	-10	-04	-10	*
Series Number	Size of Modular Valve	Bolt Number	Design Number	Design Standard
MBK: Mounting Bolt Kits for Modular Valves	10	01, 02, 03, 04	10	None: Japanese Standard "JIS" and European Design Standard 90: N.American Design Standard

Bolt Kits Selection Chart

Model Numbers	Quantity of Valves to be Stacked		Approx. Mass kg (lbs.)
	Sol. Cont. Pilot Operated Directional Valves (*-DSHG-10)	Modular Valve	
MBK-10-01-10*	1	1	3.9 (8.6)
MBK-10-02-10*	1	2	5.7 (12.6)
MBK-10-03-10*	1	3	7.4 (16.3)
MBK-10-04-10*	1	4	9.2 (20.3)

Bolt Kit Composition

Stud Bolt ----- 6 Pcs. } 1 set
 Nut ----- 6 Pcs. }

Tightening Torque:

150-170 Nm (1330-1505 in. lbs.)

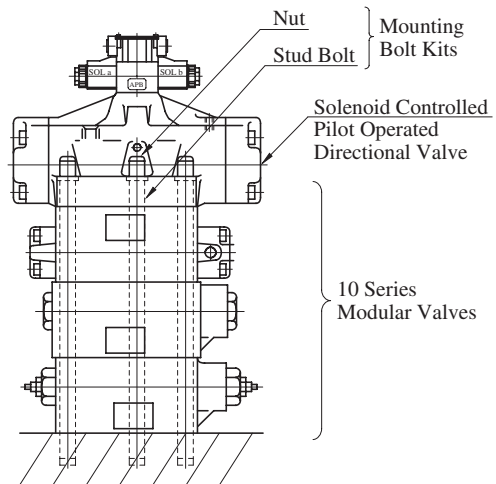

Stacking Example

MBK-10-*-10/1090

DIMENSIONS IN MILLIMETRES (INCHES)

Stud Bolt

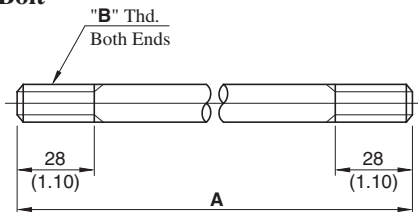

Nut

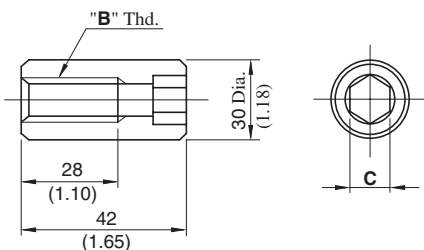

Bolt Numbers	A mm (in.)
MBK-10-01	217 (8.54)
MBK-10-02	337 (13.27)
MBK-10-03	457 (17.99)
MBK-10-04	577 (22.72)

Model Numbers	"B" Thd.	C
MBK-10-*-10	M20	17 (.67)
MBK-10-*-1090	3/4-10 UNC	15.9 (5/8)

